

# TS-42D-850-121-00-14-18-IP62-000

90-3420-003

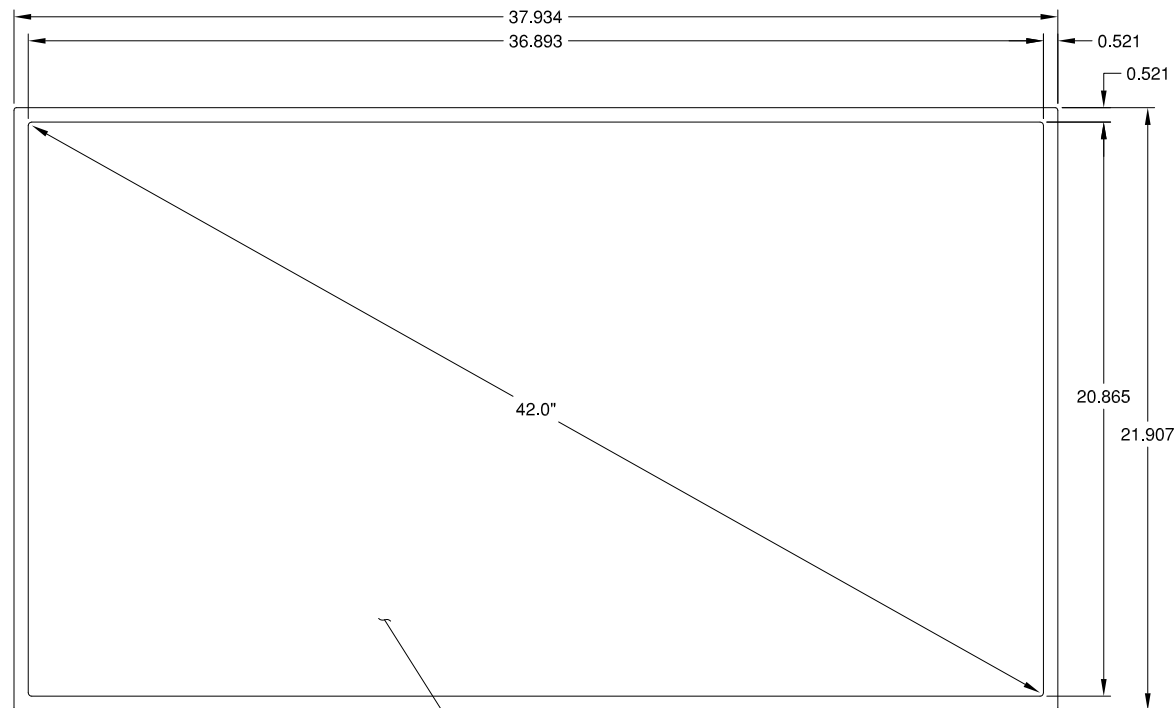

3mm ACRYLIC OVERLAY:  
ANTI REFLECTIVE BOTH SURFACES  
HARD COAT BOTH SURFACES

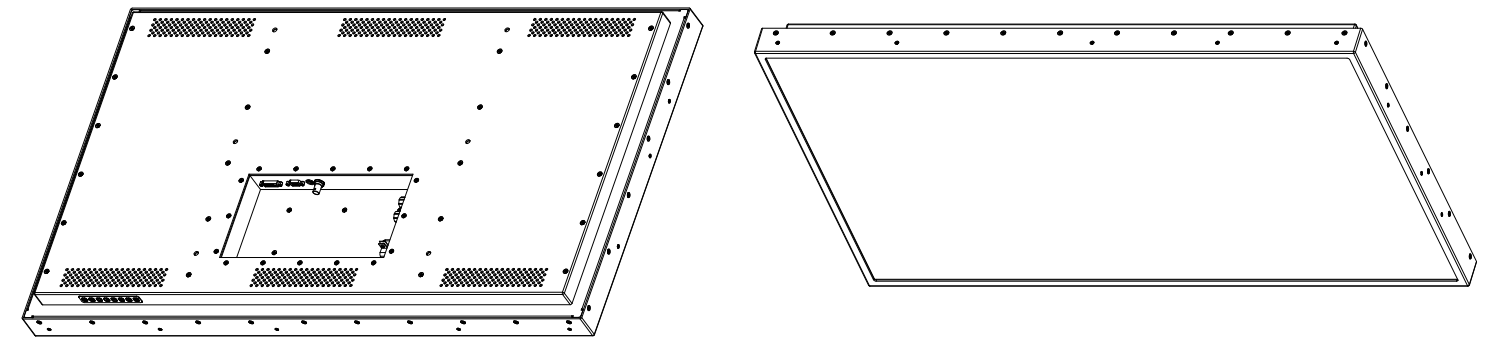
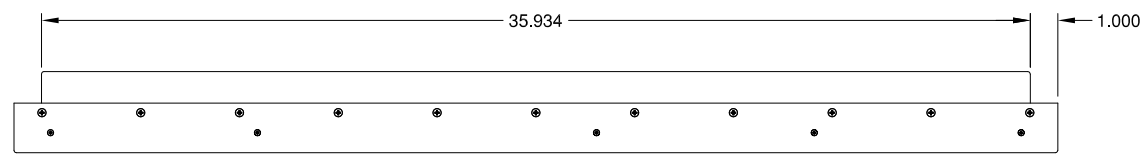
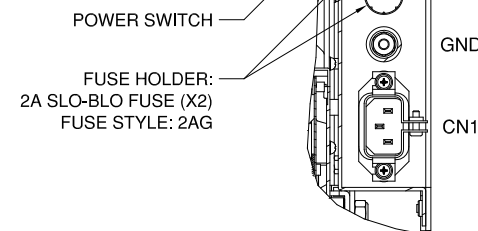
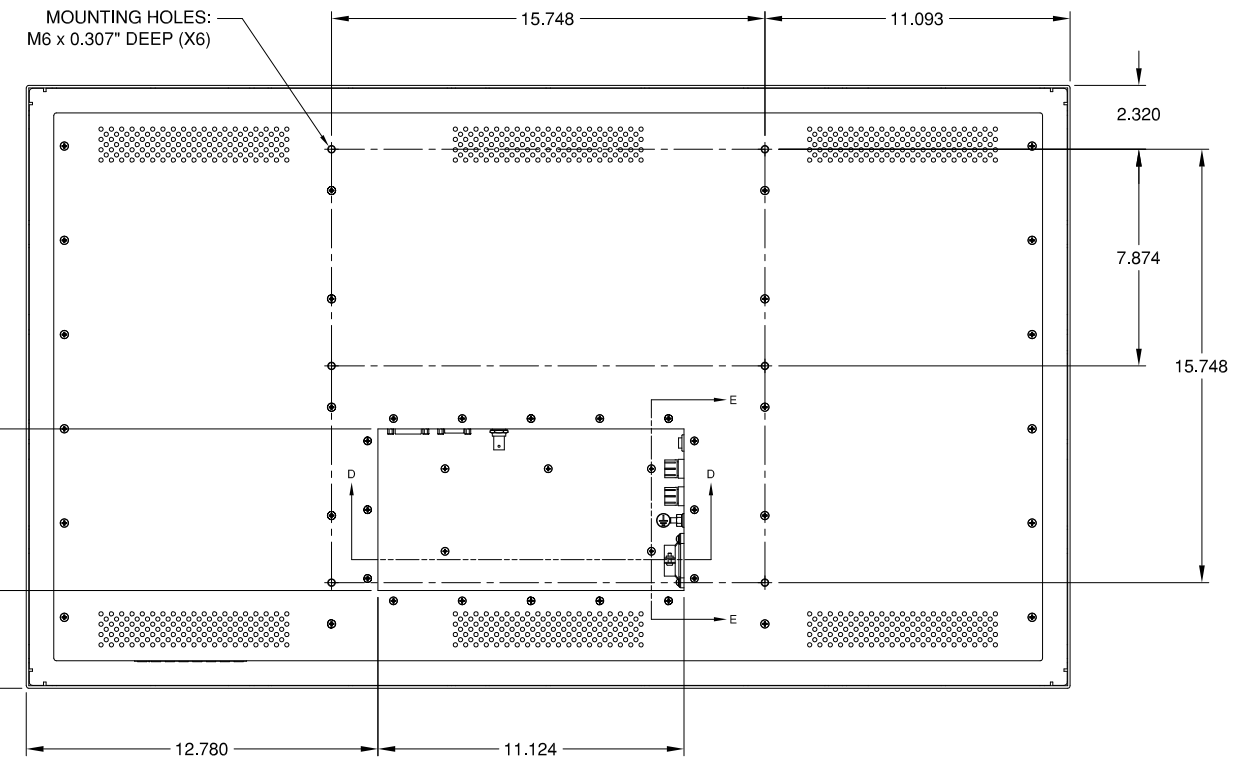
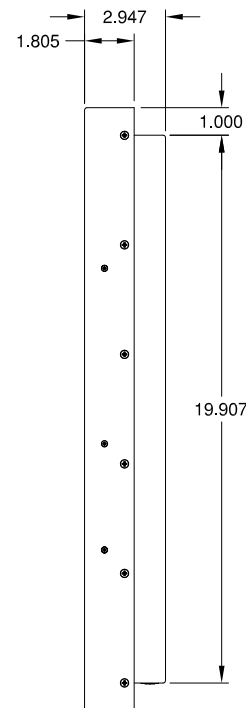
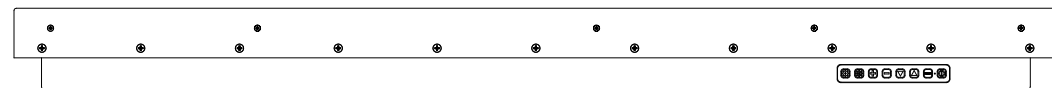

SECTION E-E

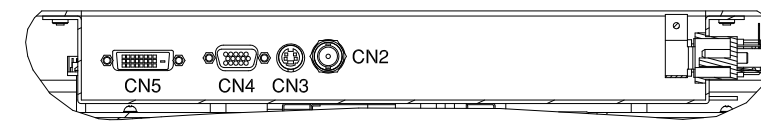

SECTION D-D

THIS DOCUMENT CONTAINS PROPRIETARY INFORMATION OF GENERAL DIGITAL AND IS NOT TO BE DISCLOSED, REPRODUCED OR PUBLISHED WITHOUT WRITTEN CONSENT FROM GENERAL DIGITAL. THIS DOCUMENT MUST BE RENDERED ILLEGIBLE WHEN BEING DISCARDED. © COPYRIGHT 2016. ALL RIGHTS RESERVED.

UNLESS OTHERWISE SPECIFIED DIMENSIONS ARE IN INCHES  
TOLERANCES ARE:  
FRACTIONS DECIMALS ANGLES  
±1/32 .X ±.050 ±0° 30'  
.XX ±.031  
.XXX±.020

CONNECTOR CHART		
DESIGNATION	FUNCTION	TYPE
CN1	AC INPUT	IEC-320
CN2	COMPOSITE VIDEO INPUT	BNC STYLE
CN3	S-VIDEO INPUT	4-PIN MINI DIN
CN4	ANALOG VIDEO INPUT	DE-15-S
CN5	DVI-D INPUT	DVI-D
GND	GROUND STUD	10-32 UNF-2A

MECHANICAL OUTLINE ONLY. SPECIFICATIONS SUBJECT TO CHANGE WITHOUT NOTICE. U.O.S. ALL DIMENSIONS ARE IN INCHES.

APPROVALS		DATE
DRAWN	G.L.	30-Jun-16
CHECKED	J.H.	
APPROVED	T.R.	
DO NOT SCALE DRAWING		



*The Innovators of Flat Panel Technology*  
8 Nutmeg Road South, South Windsor, CT 06074  
(860) 282-2900 www.GeneralDigital.com

TITAN STANDALONE  
42.0" WUXGA MONITOR

REV	DATE	ECN	DESCRIPTION	BY
V2	26-Jul-16	E004729	CHANGED OVERLAY THICKNESS AND FINISH UPDATED MODEL NUMBER FOR OVERLAY CHANGE	GL
V1	11-Jul-16	E004719	CORRECTED POWER SUPPLY IN MODEL NUMBER	GL

**B**

CAGE CODE	DWG. NO.	REV
1JA77	3420-003-97	V2