

DETAIL A

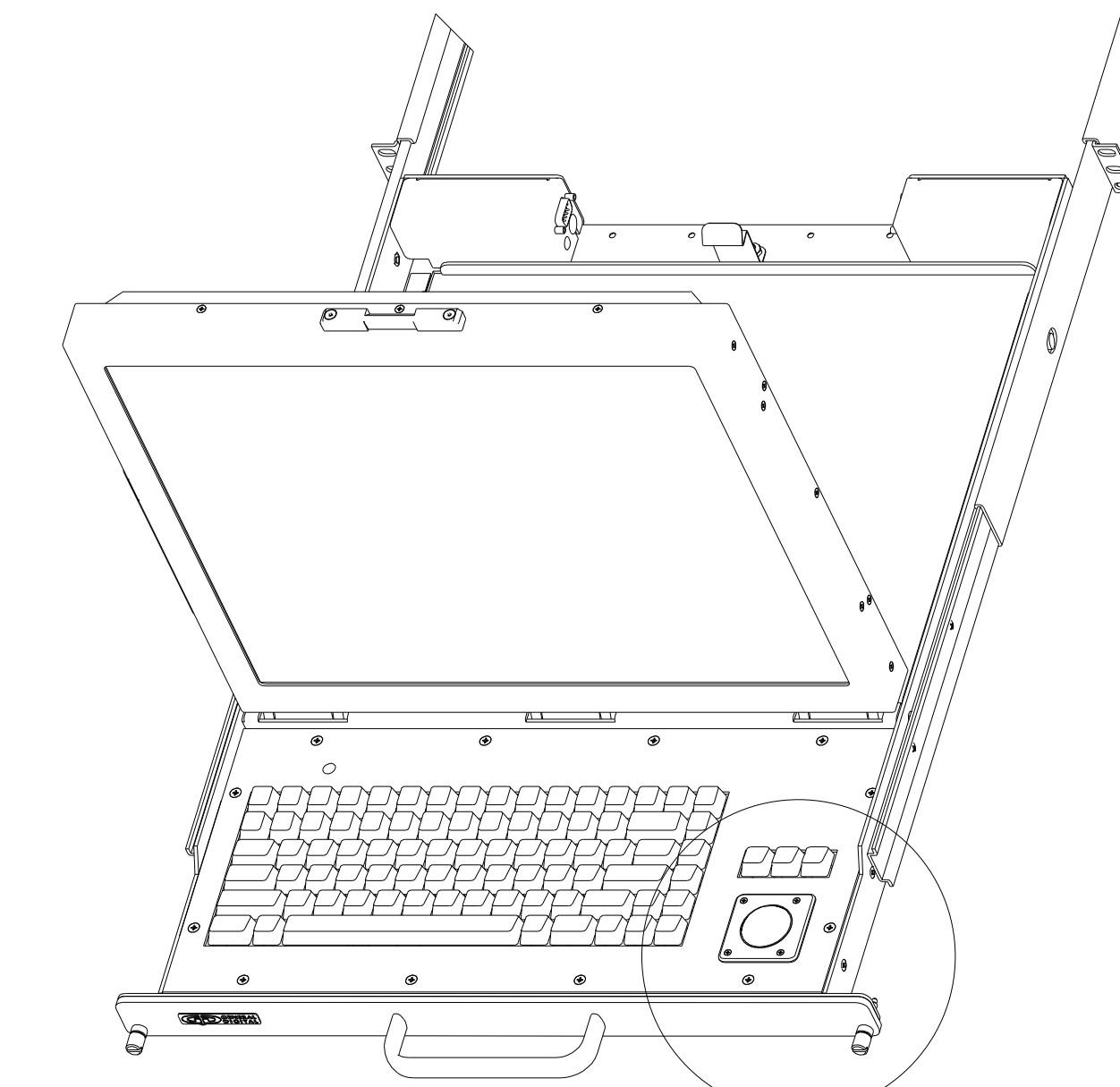

OPEN/DEPLOYED POSITION

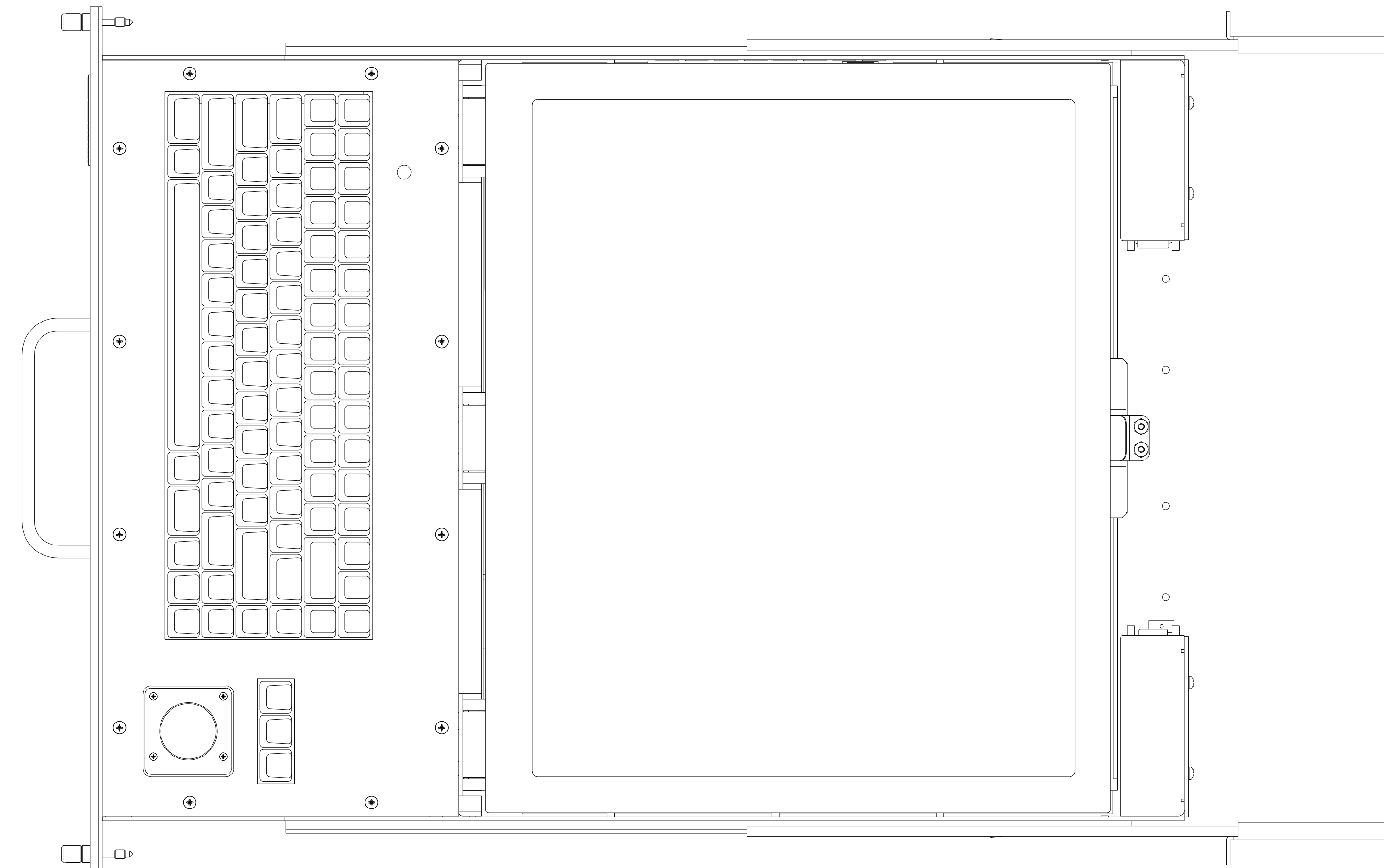
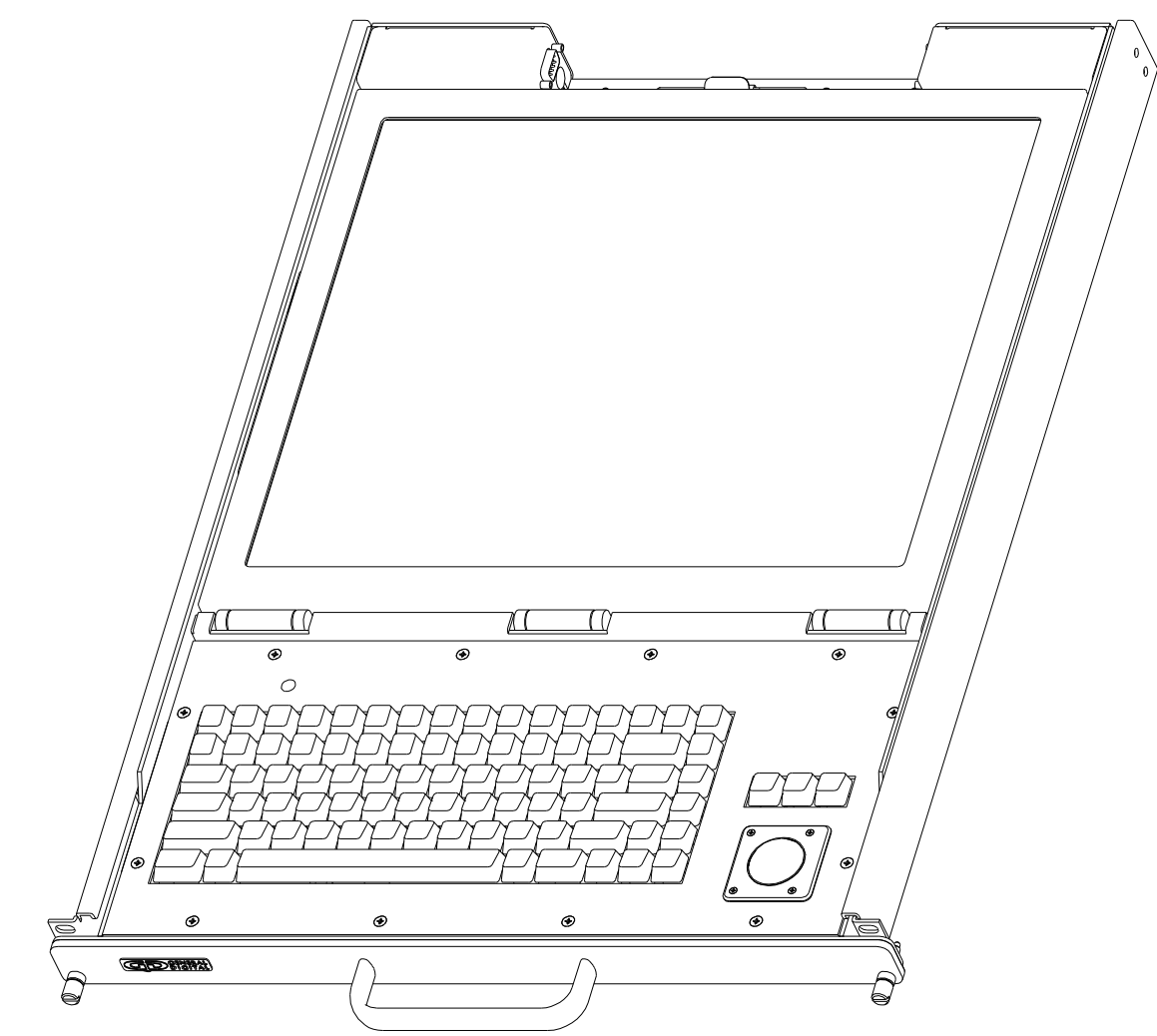

CLOSED/STOWED POSITION

SEE DETAIL A

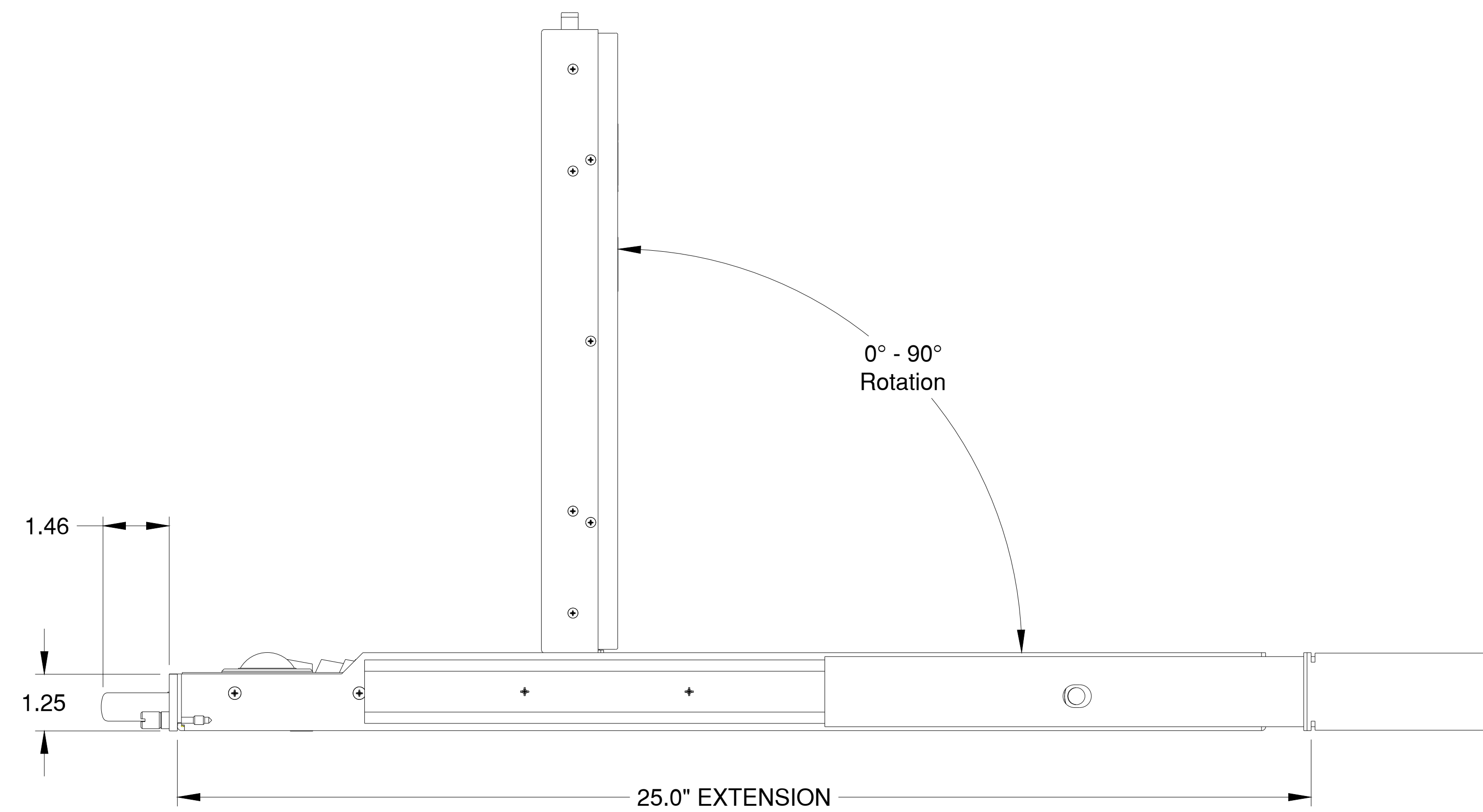
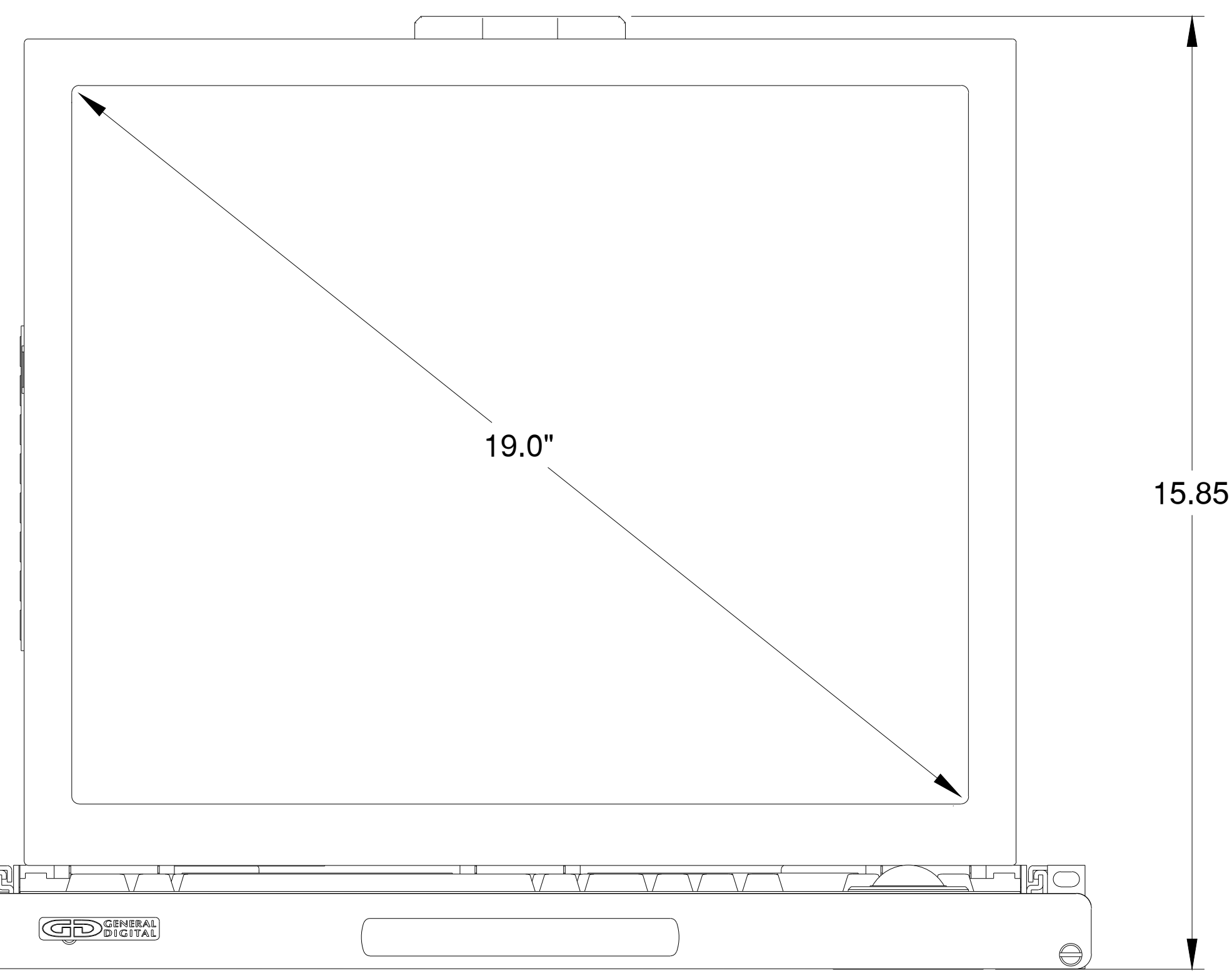

0° - 90° Rotation

25.0" EXTENSION

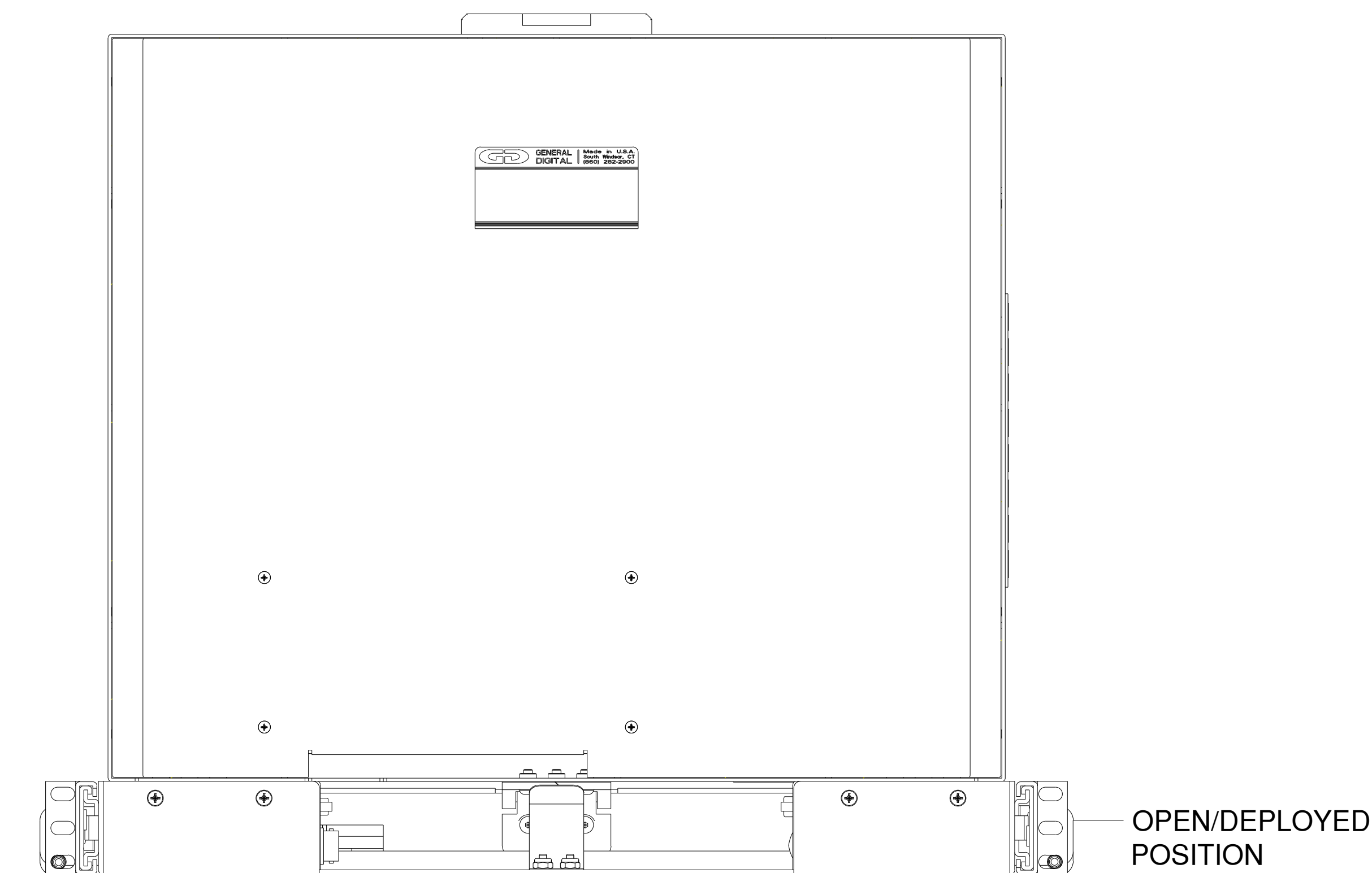

OPEN/DEPLOYED POSITION

DISPLAY HOLD-DOWN (SPRING LATCH)

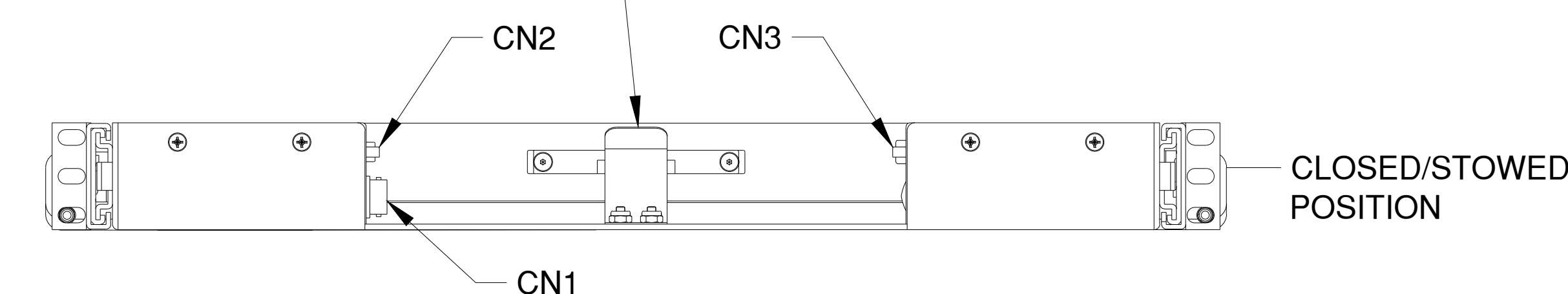

CLOSED/STOWED POSITION

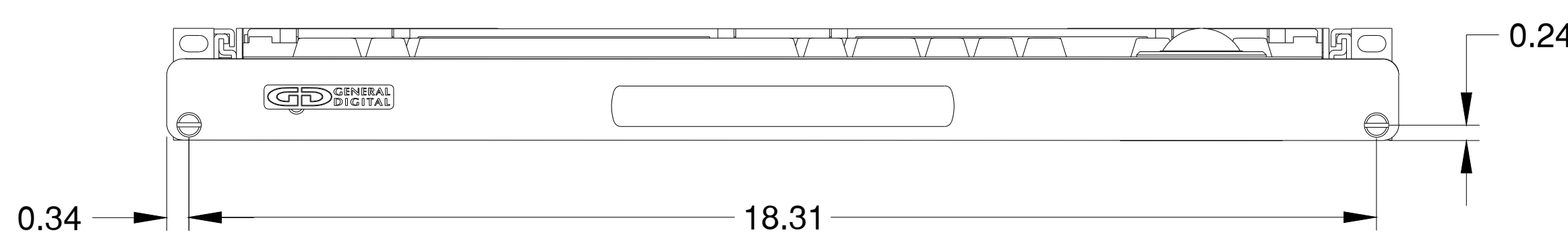

THIS DOCUMENT CONTAINS PROPRIETARY INFORMATION OF GENERAL DIGITAL AND IS NOT TO BE DISCLOSED, REPRODUCED OR PUBLISHED WITHOUT WRITTEN CONSENT FROM GENERAL DIGITAL. THIS DOCUMENT MUST BE RENDERED ILLEGIBLE WHEN BEING DISCARDED. © COPYRIGHT 2013. ALL RIGHTS RESERVED.

UNLESS OTHERWISE SPECIFIED DIMENSIONS ARE IN INCHES
TOLERANCES ARE:
FRACTIONS DECIMALS ANGLES
±1/32 .X ±.050 ±0° 30'
.XX ±.031
.XXX±.020

CONNECTOR CHART

DESIGNATION	FUNCTION	TYPE
CN1	+12 VDC INPUT	6-PIN HIROSE
CN2	ANALOG VIDEO INPUT	HDD-15-S
CN3	KEYBOARD INPUT	DE-9-P

MECHANICAL OUTLINE ONLY. SPECIFICATIONS SUBJECT TO CHANGE WITHOUT NOTICE. U.O.S. ALL DIMENSIONS ARE IN INCHES.

APPROVALS		DATE
DRAWN	G.L.	26-JUNE-13
CHECKED	T.R.	26-JUNE-13
APPROVED	B.G.	26-JUNE-13



The Innovators of Flat Panel Technology
8 Nutmeg Road South, South Windsor, CT 06074
(860) 282-2900 www.GeneralDigital.com

SlimLine 1U
19.0" SXGA FLAT PANEL MONITOR

DO NOT SCALE DRAWING

B

CAGE CODE
1JA77

DWG. NO.
13-58

REV
-

REV	DATE	ECN	DESCRIPTION	BY