

THIS DOCUMENT CONTAINS PROPRIETARY INFORMATION OF GENERAL DIGITAL AND IS NOT TO BE DISCLOSED, REPRODUCED OR PUBLISHED WITHOUT WRITTEN CONSENT FROM GENERAL DIGITAL. THIS DOCUMENT MUST BE RENDERED ILLEGIBLE WHEN BEING DISCARDED. © COPYRIGHT 2007. ALL RIGHTS RESERVED.

CM-24D-815-35-00-00-00-0092

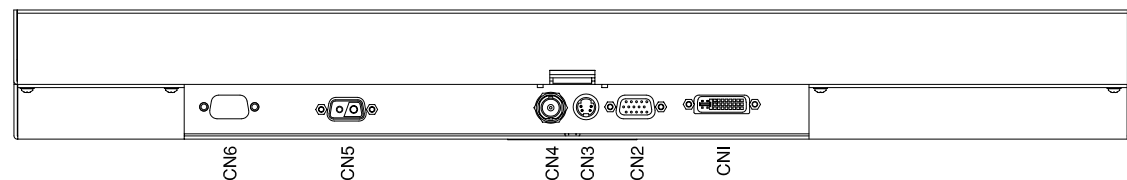
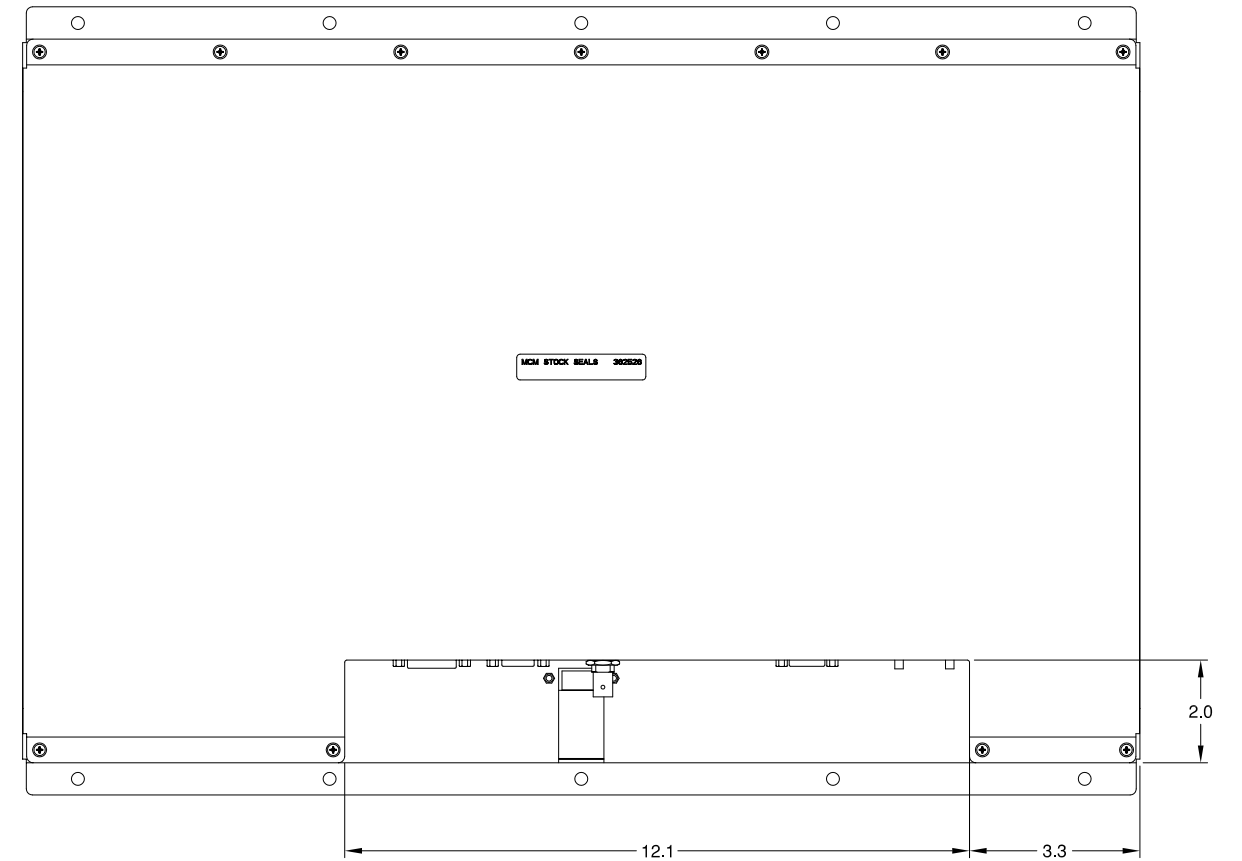
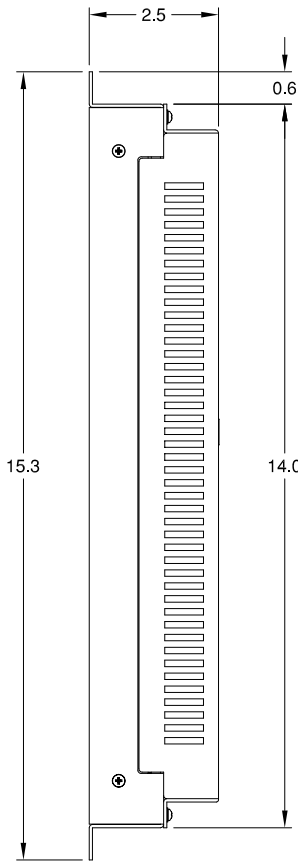
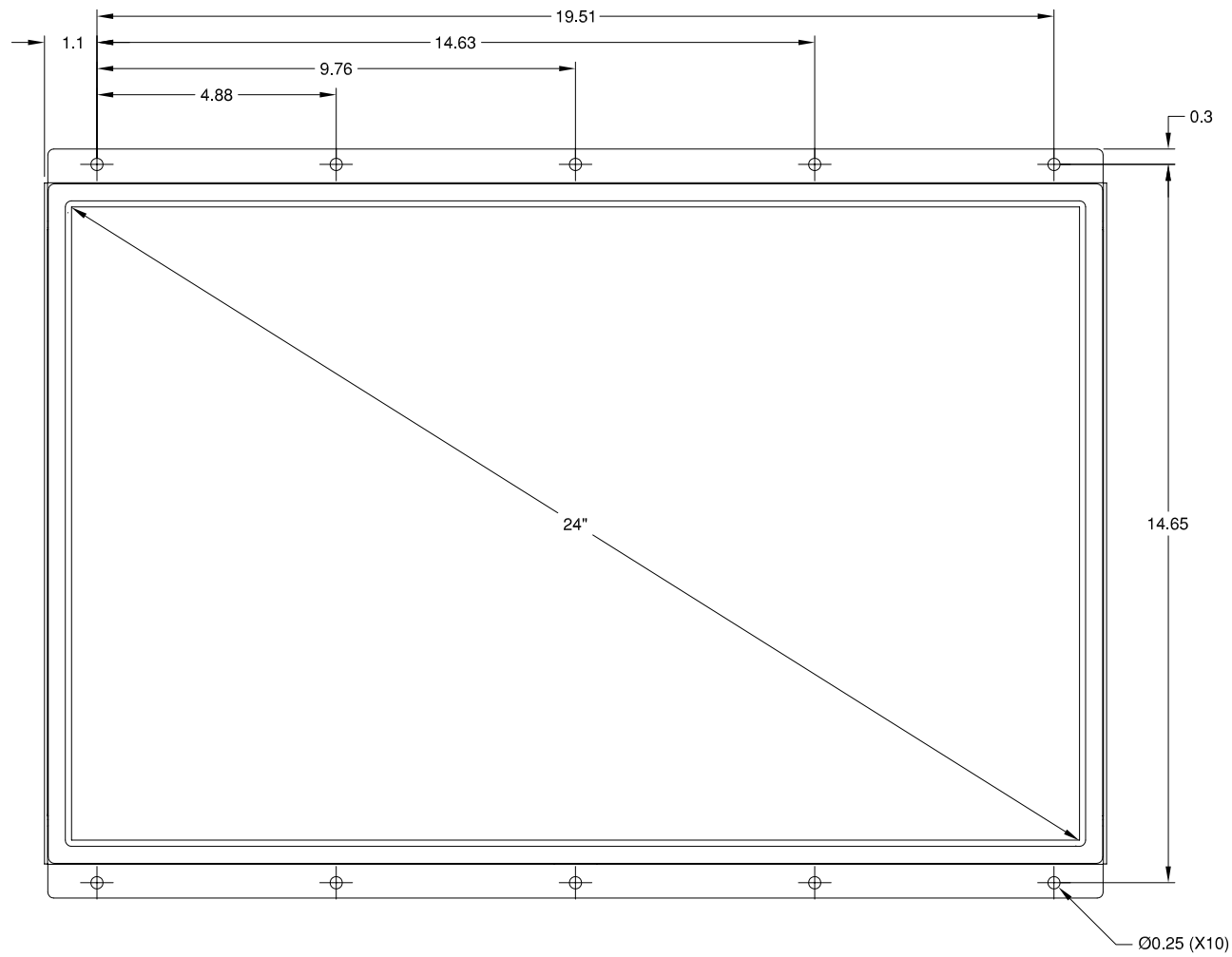
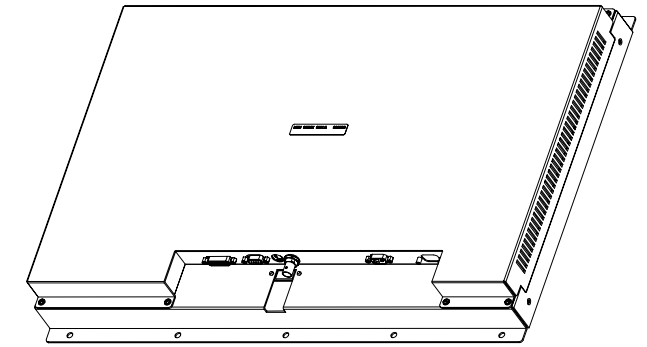
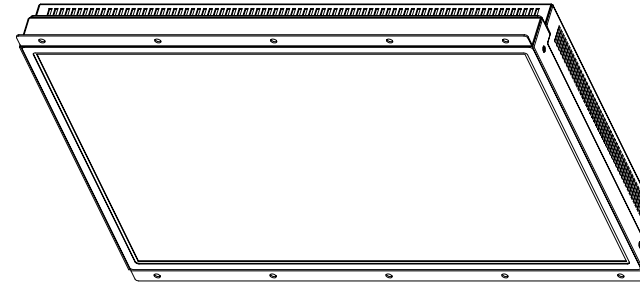
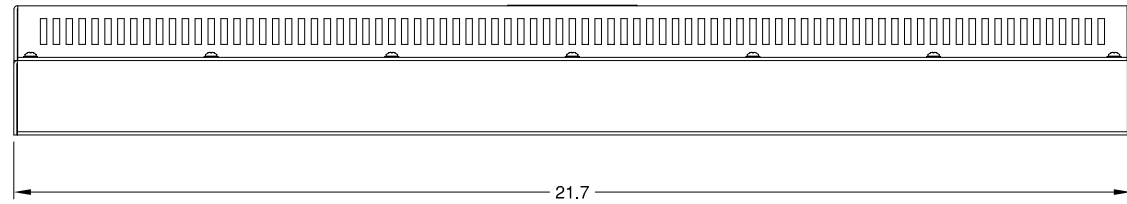

UNLESS OTHERWISE SPECIFIED DIMENSIONS ARE IN INCHES TOLERANCES ARE:
 FRACTIONS DECIMALS ANGLES
 ±1/32 .X ±.031 ±0° 30'
 .XX ±.020

CONNECTOR CHART		
DESIGNATION	FUNCTION	TYPE
CN1	DVI-D INPUT	DVI-D
CN2	ANALOG VIDEO INPUT	DE-15-S
CN3	S-VIDEO INPUT	4-PIN MINI DIN
CN4	COMPOSITE VIDEO INPUT	BNC STYLE
CN5	+12 VDC INPUT	DE-2W2-P
CN6	SERIAL INPUT (OPTIONAL)	DE-9-S

MECHANICAL OUTLINE ONLY. SPECIFICATIONS SUBJECT TO CHANGE WITHOUT NOTICE. U.O.S. ALL DIMENSIONS ARE IN INCHES.	
APPROVALS	DATE
DRAWN C.P.	29-Nov-07
CHECKED T.R.	29-Nov-07
APPROVED B.G.	29-Nov-07
DO NOT SCALE DRAWING	

GD GENERAL DIGITAL
The Innovators of Flat Panel Technology
 8 Nutmeg Road South, South Windsor, CT 06074
 (860) 282-2900 www.GeneralDigital.com

CHASSIS MONITOR KIT 24" WUXGA FLAT PANEL MONITOR			
B	CAGE CODE	DWG. NO.	REV
	1JA77	07-31	-