

(X) OPTION	UNIT DESCRIPTION
-	BARRACUDA STANDALONE
S	BARRACUDA STANDALONE SOLAR
SN	BARRACUDA STANDALONE SOLAR/NVIS
D	BARRACUDA STANDALONE DAYLIGHT READABLE

(X)BS-15X-cccc-108-00-31-gg-SA39-137

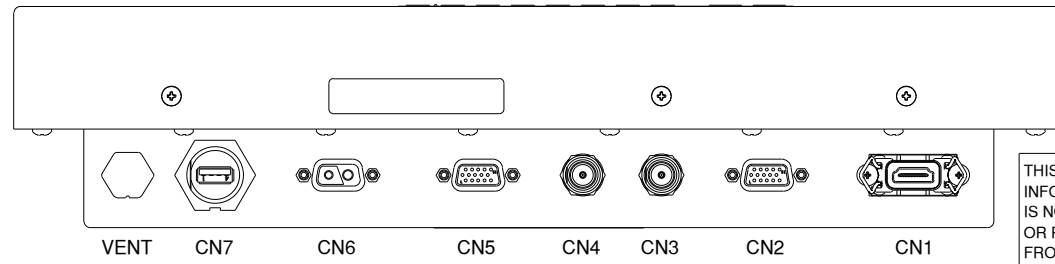
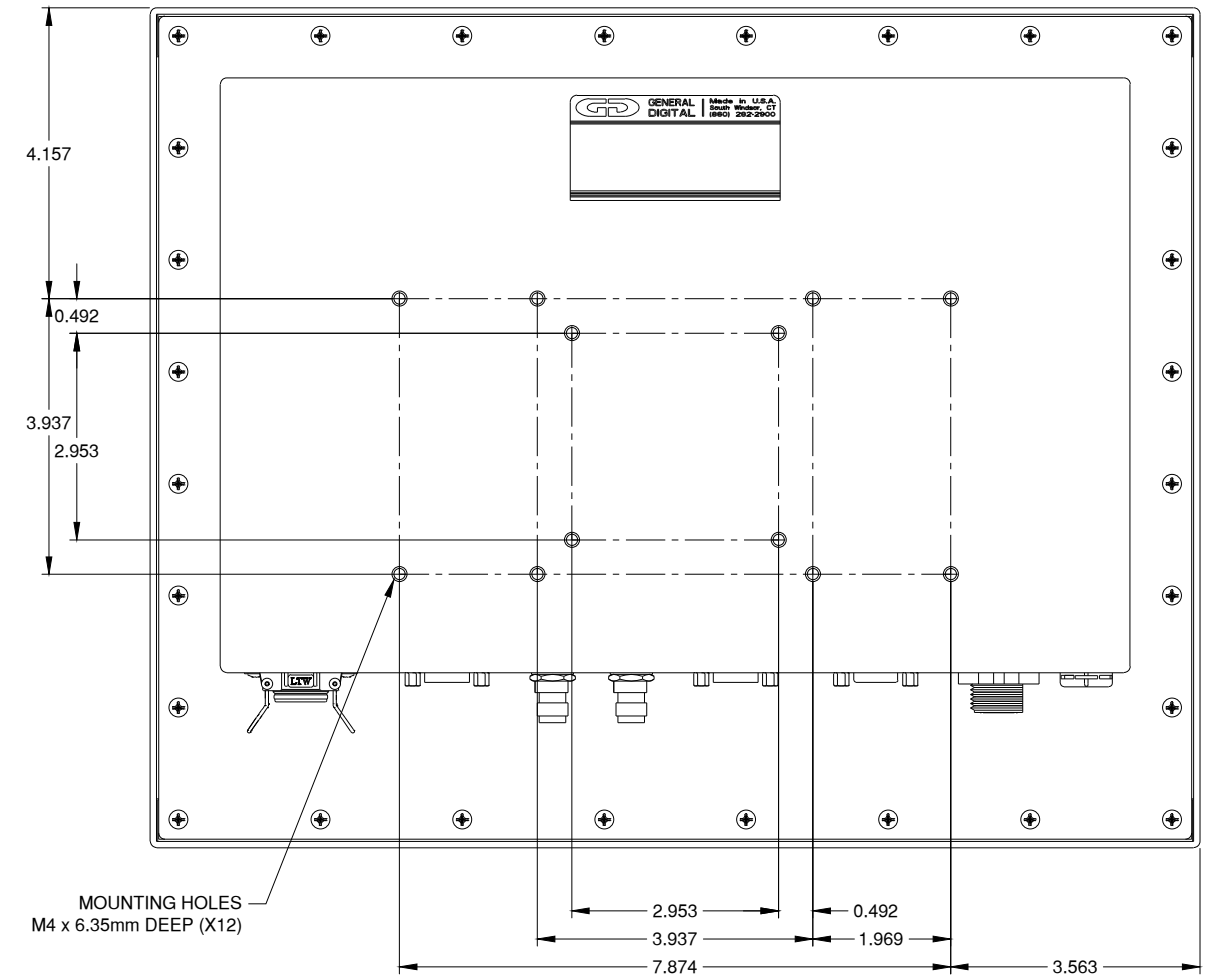
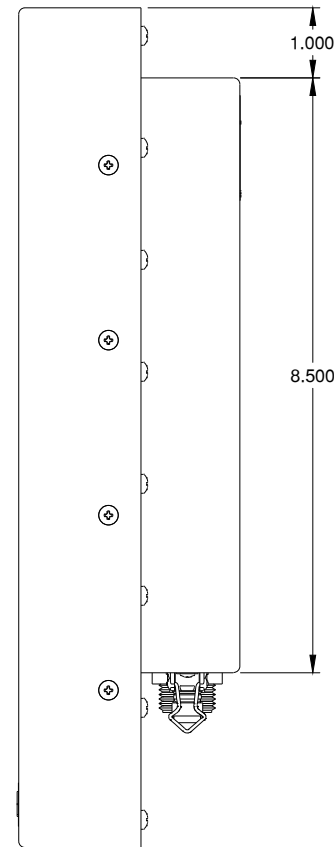
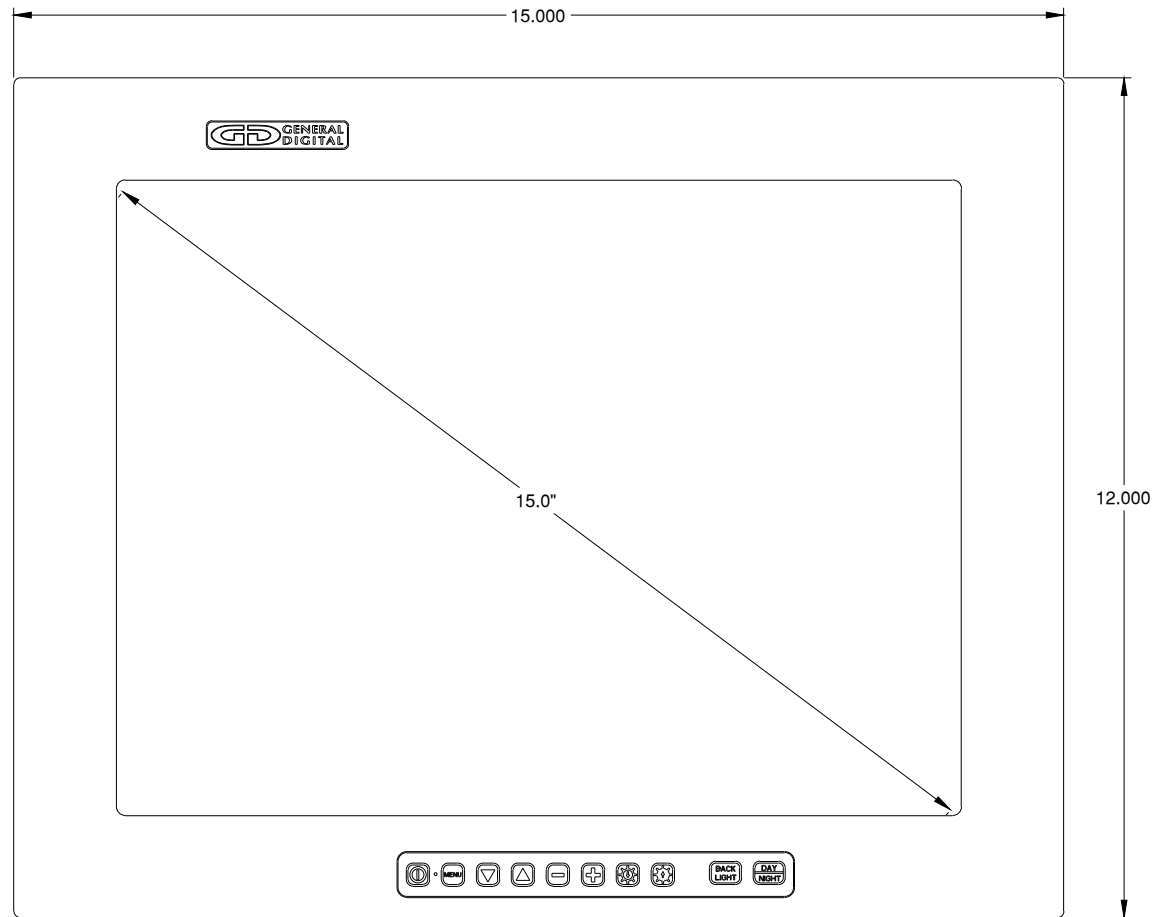
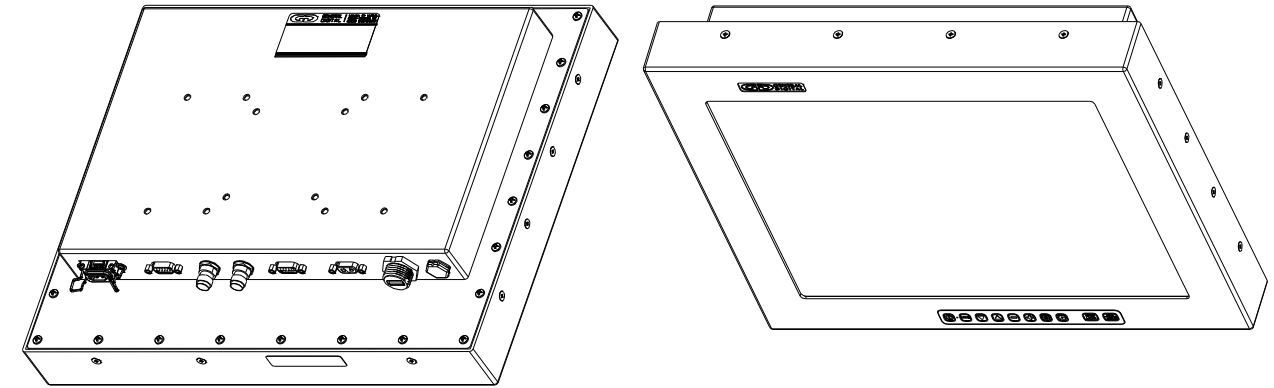
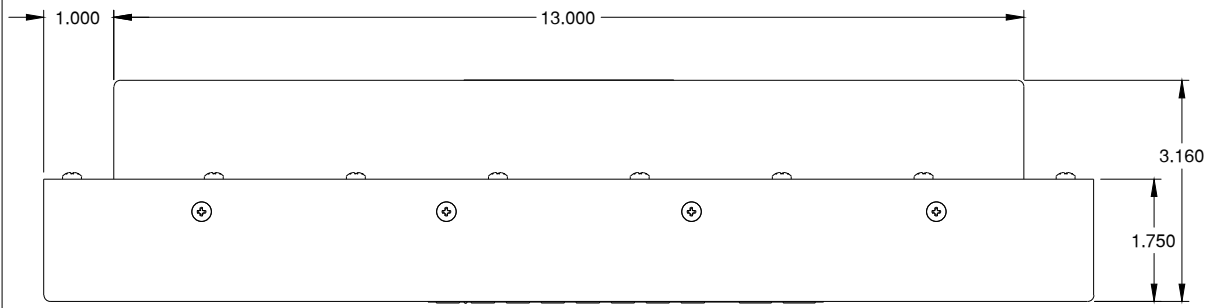

THIS DOCUMENT CONTAINS PROPRIETARY INFORMATION OF GENERAL DIGITAL AND IS NOT TO BE DISCLOSED, REPRODUCED OR PUBLISHED WITHOUT WRITTEN CONSENT FROM GENERAL DIGITAL. THIS DOCUMENT MUST BE RENDERED ILLEGIBLE WHEN BEING DISCARDED. ©COPYRIGHT 2012. ALL RIGHTS RESERVED.

UNLESS OTHERWISE SPECIFIED DIMENSIONS ARE IN INCHES TOLERANCES ARE:  
 FRACTIONS DECIMALS ANGLES  
 ±1/32 .X ±.050 ±0° 30'  
 .XX ±.031  
 .XXX±.020

CONNECTOR CHART		
DESIGNATOR	FUNCTION	TYPE
CN1	DIGITAL VIDEO INPUT	HDMI CONN
CN2	ANALOG VIDEO INPUT	DE-15-S
CN3	COMPOSITE VIDEO INPUT	TNC STYLE
CN4	COMPOSITE VIDEO INPUT	TNC STYLE
CN5	ANALOG VIDEO INPUT	DE-15-S
CN6	+24 VDC INPUT	DE-2W2-S
CN7	TOUCH - USB	USB TYPE A

MECHANICAL OUTLINE ONLY. SPECIFICATIONS SUBJECT TO CHANGE WITHOUT NOTICE. U.O.S. ALL DIMENSIONS ARE IN INCHES.	
APPROVALS	DATE
DRAWN G.L.	28-Mar-14
CHECKED K.H.	
APPROVED B.G.	
<b>DO NOT SCALE DRAWING</b>	



**GENERAL DIGITAL**  
*The Innovators of Flat Panel Technology*  
 8 Nutmeg Road South, South Windsor, CT 06074  
 (860) 282-2900 www.GeneralDigital.com

<b>BARRACUDA STANDALONE</b>			
<b>15.0" XGA MONITOR</b>			
<b>B</b>	CAGE CODE 1JA77	DWG. NO. 14-34	REV A

REV	DATE	ECN	DESCRIPTION	BY
A	16-May-14	-	ADDED DISPLAY OPTIONS TABLE	GL