

(X) OPTION	UNIT DESCRIPTION
-	BARRACUDA STANDALONE
S	BARRACUDA STANDALONE SOLAR
SN	BARRACUDA STANDALONE SOLAR/NVIS
D	BARRACUDA STANDALONE DAYLIGHT READABLE

(X)BS-24D-cccc-108-00-31-13-IP14-000

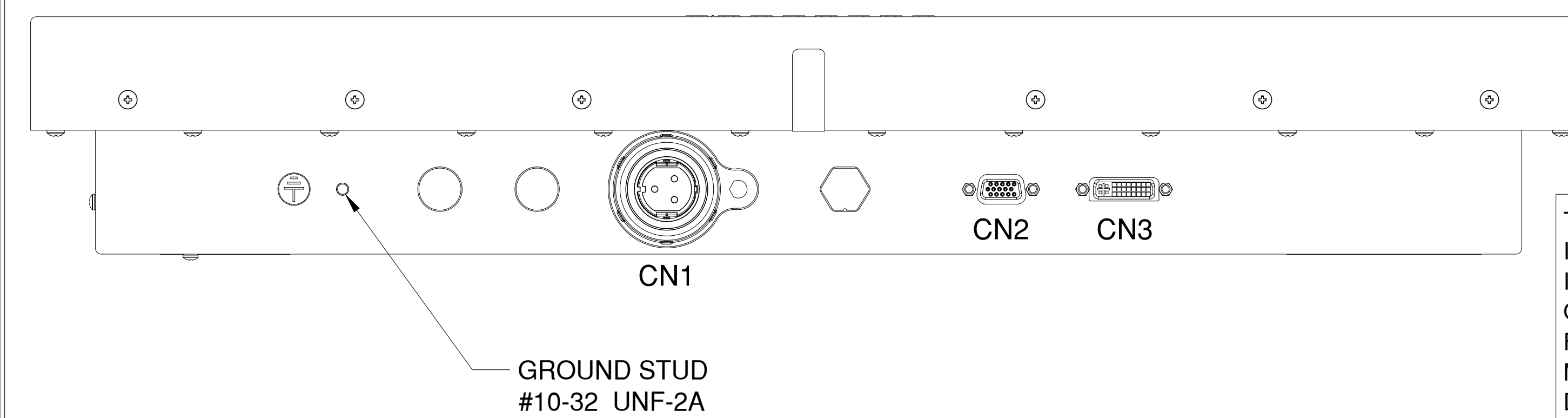
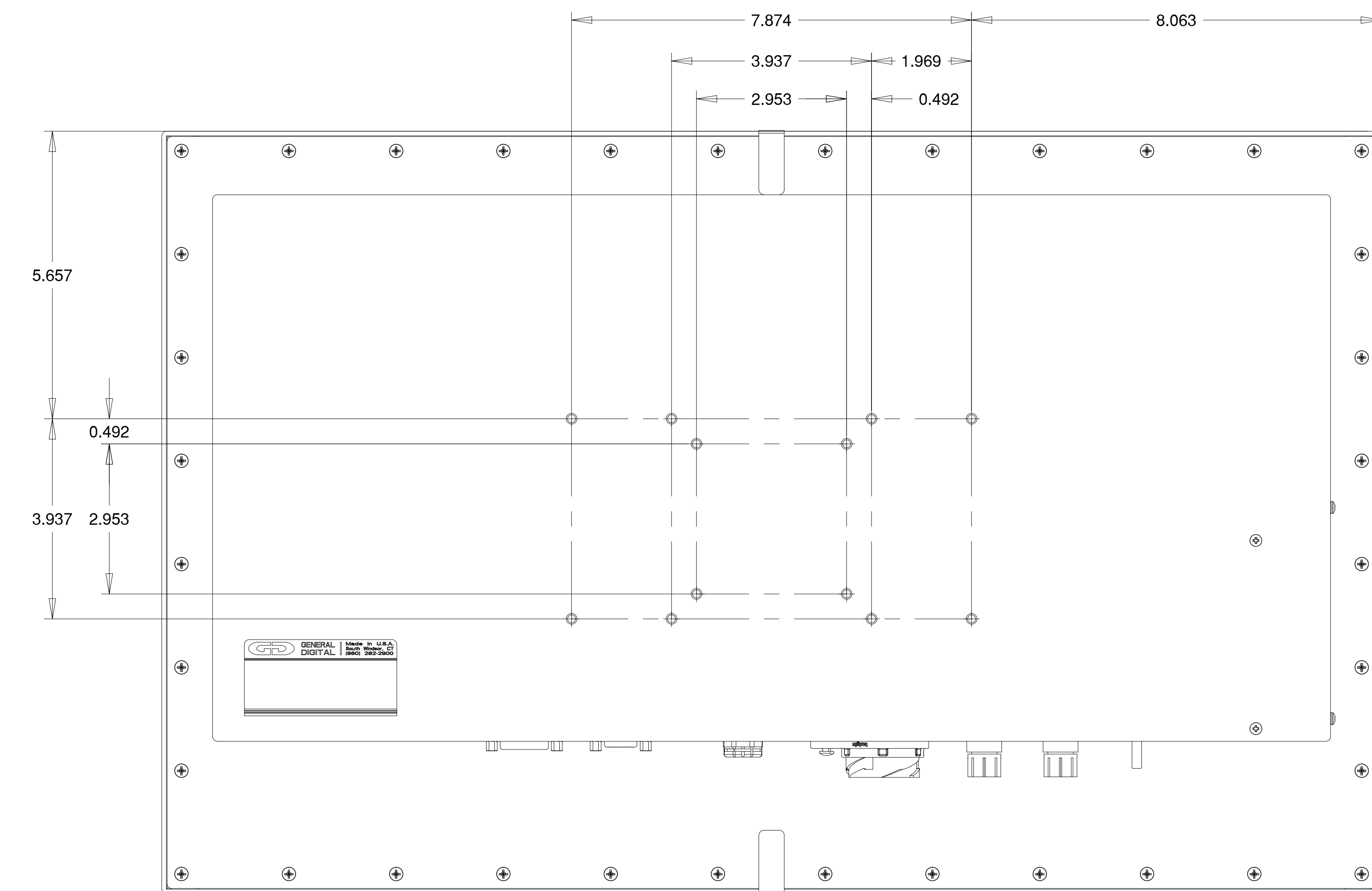
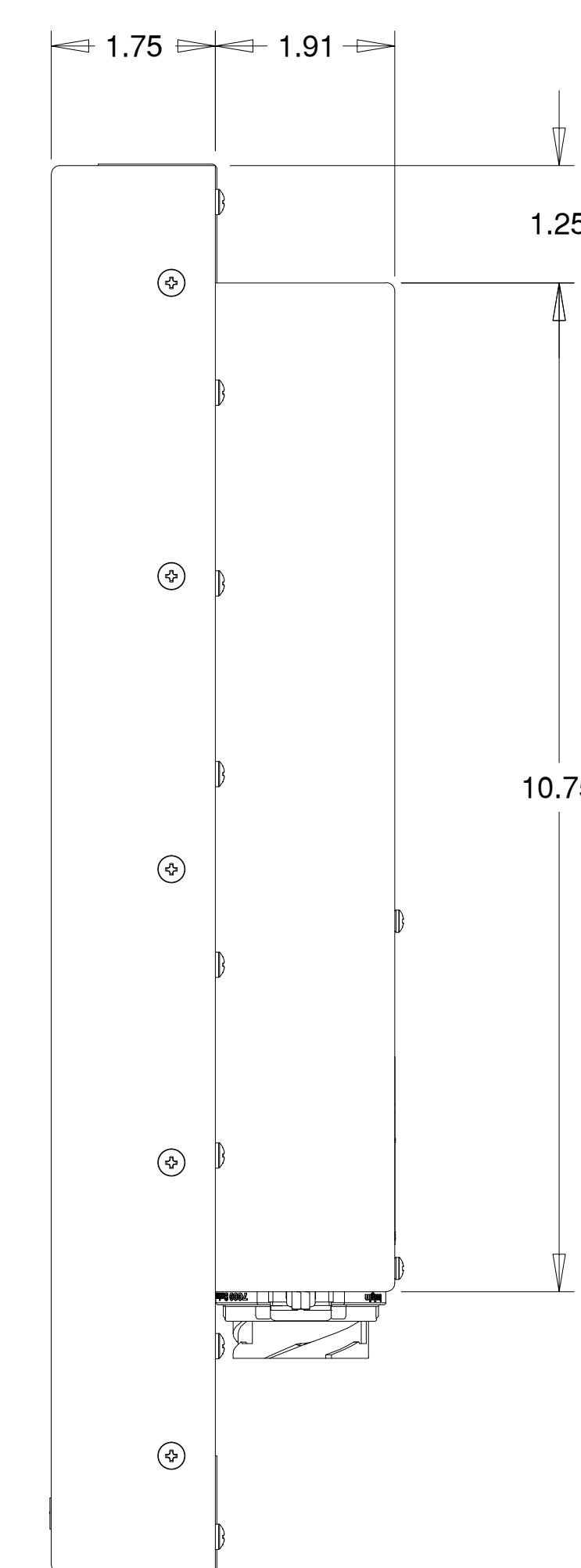
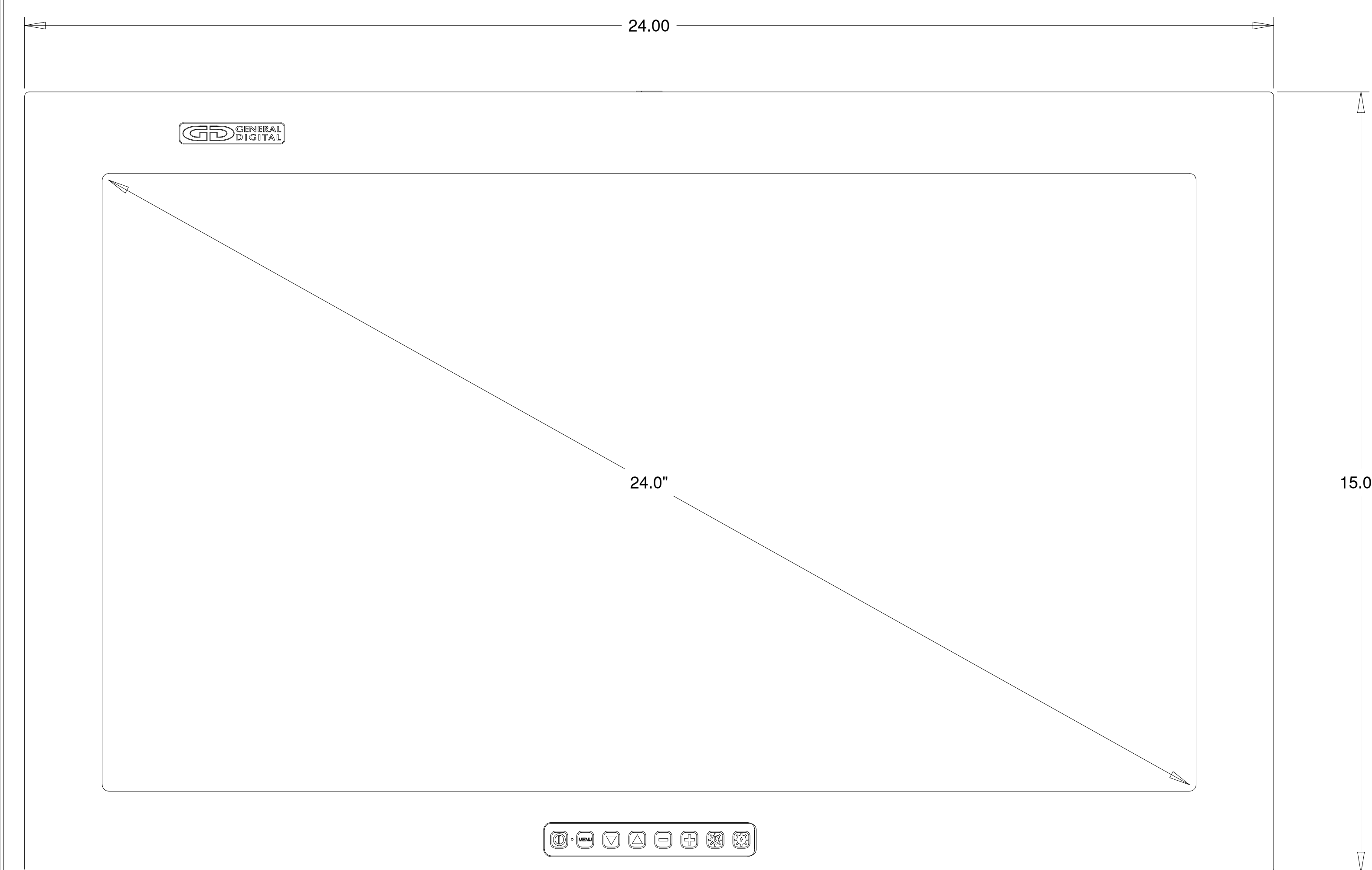
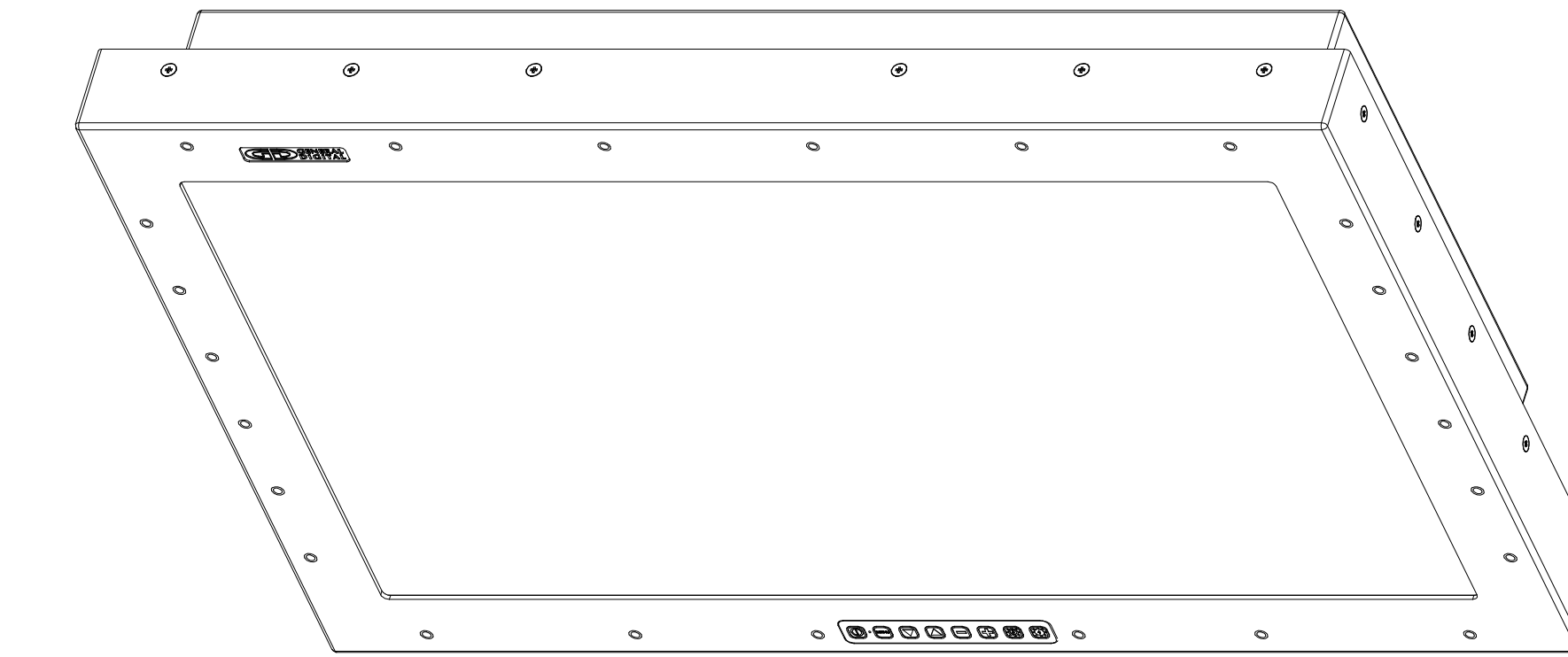
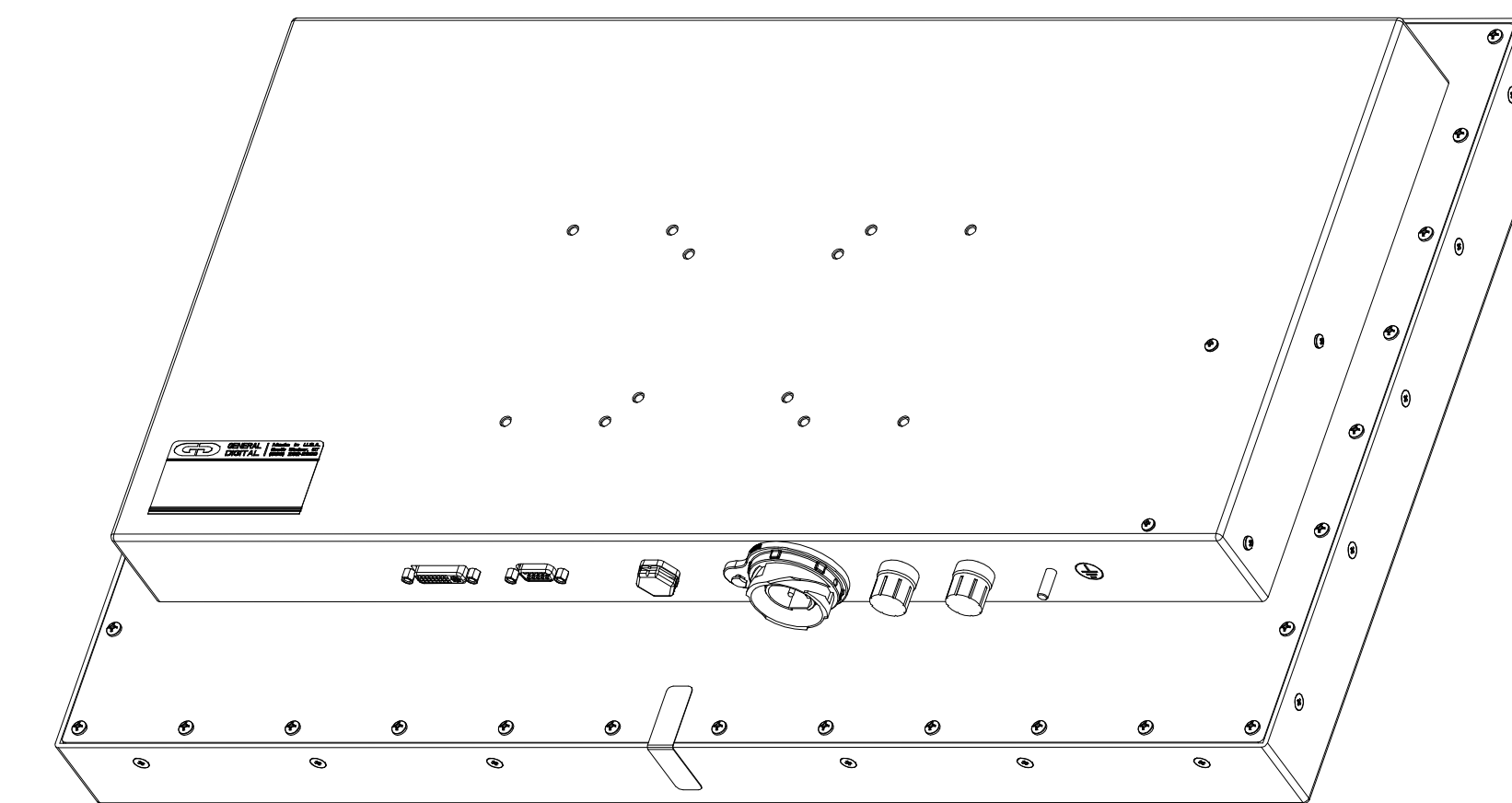
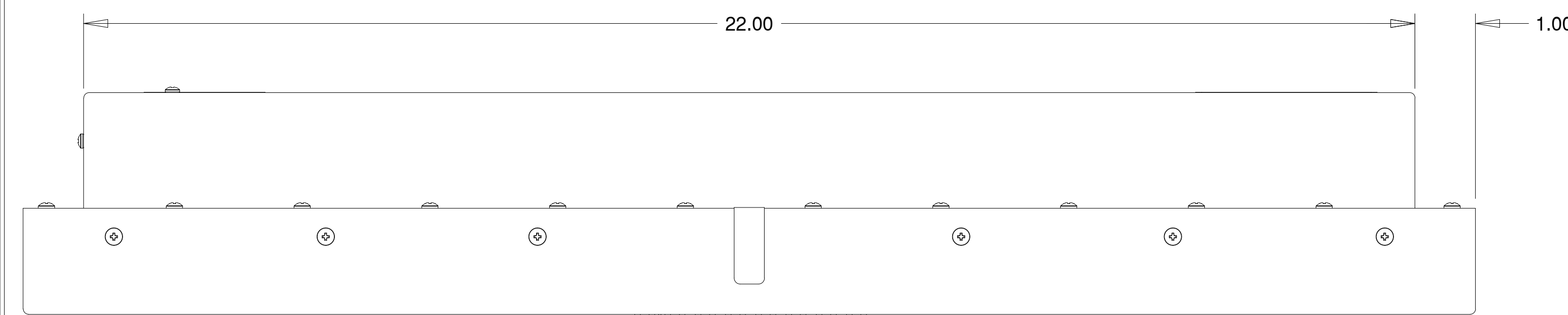

THIS DOCUMENT CONTAINS PROPRIETARY INFORMATION OF GENERAL DIGITAL AND IS NOT TO BE DISCLOSED, REPRODUCED OR PUBLISHED WITHOUT WRITTEN CONSENT FROM GENERAL DIGITAL. THIS DOCUMENT MUST BE RENDERED ILLEGIBLE WHEN BEING DISCARDED. © COPYRIGHT 2011. ALL RIGHTS RESERVED.

UNLESS OTHERWISE SPECIFIED DIMENSIONS ARE IN INCHES  
TOLERANCES ARE:  
FRACTIONS DECIMALS ANGLES  
±1/32 .X ±.050 ±0° 30'  
.XX ±.031  
.XXX±.020

CONNECTOR CHART

DESIGNATION	FUNCTION	TYPE
CN1	AC INPUT	PXM7012/03P/ST
CN2	ANALOG VIDEO INPUT	DE-15-S (SEALED)
CN3	DVI INPUT	DVI-D (SEALED)

MECHANICAL OUTLINE ONLY. SPECIFICATIONS SUBJECT TO CHANGE WITHOUT NOTICE. U.O.S. ALL DIMENSIONS ARE IN INCHES.

APPROVALS		DATE
DRAWN	G.L.	10-Oct-14
CHECKED	K.H.	
APPROVED	B.G.	

DO NOT SCALE DRAWING

**GD GENERAL DIGITAL**  
*The Innovators of Flat Panel Technology*  
8 Nutmeg Road South, South Windsor, CT 06074  
(860) 282-2900 www.GeneralDigital.com

BARRACUDA STANDALONE  
24.0" WUXGA MONITOR

REV	DATE	ECN	DESCRIPTION	BY

CAGE CODE	DWG. NO.	REV
B 1JA77	14-105	-