

(X) OPTION	UNIT DESCRIPTION
-	SABER STANDALONE
S	SABER STANDALONE SOLAR
SN	SABER STANDALONE SOLAR/NVIS
D	SABER STANDALONE DAYLIGHT READABLE

(X)GD-10X-cccc-110-00-16-gg-SA47-164

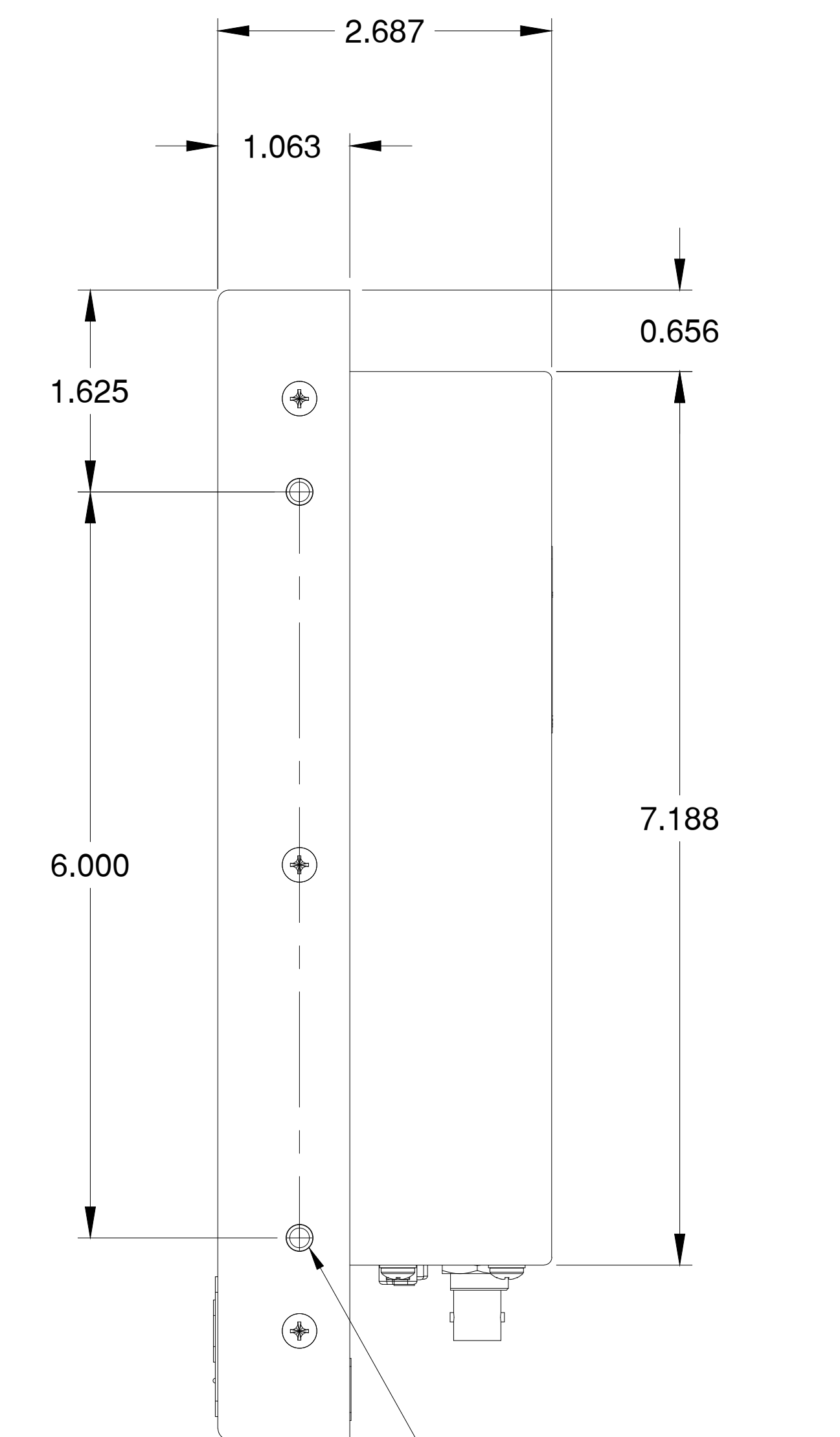

MOUNTING HOLES  
M4 x 6.35mm DEEP  
(X2) EACH SIDE

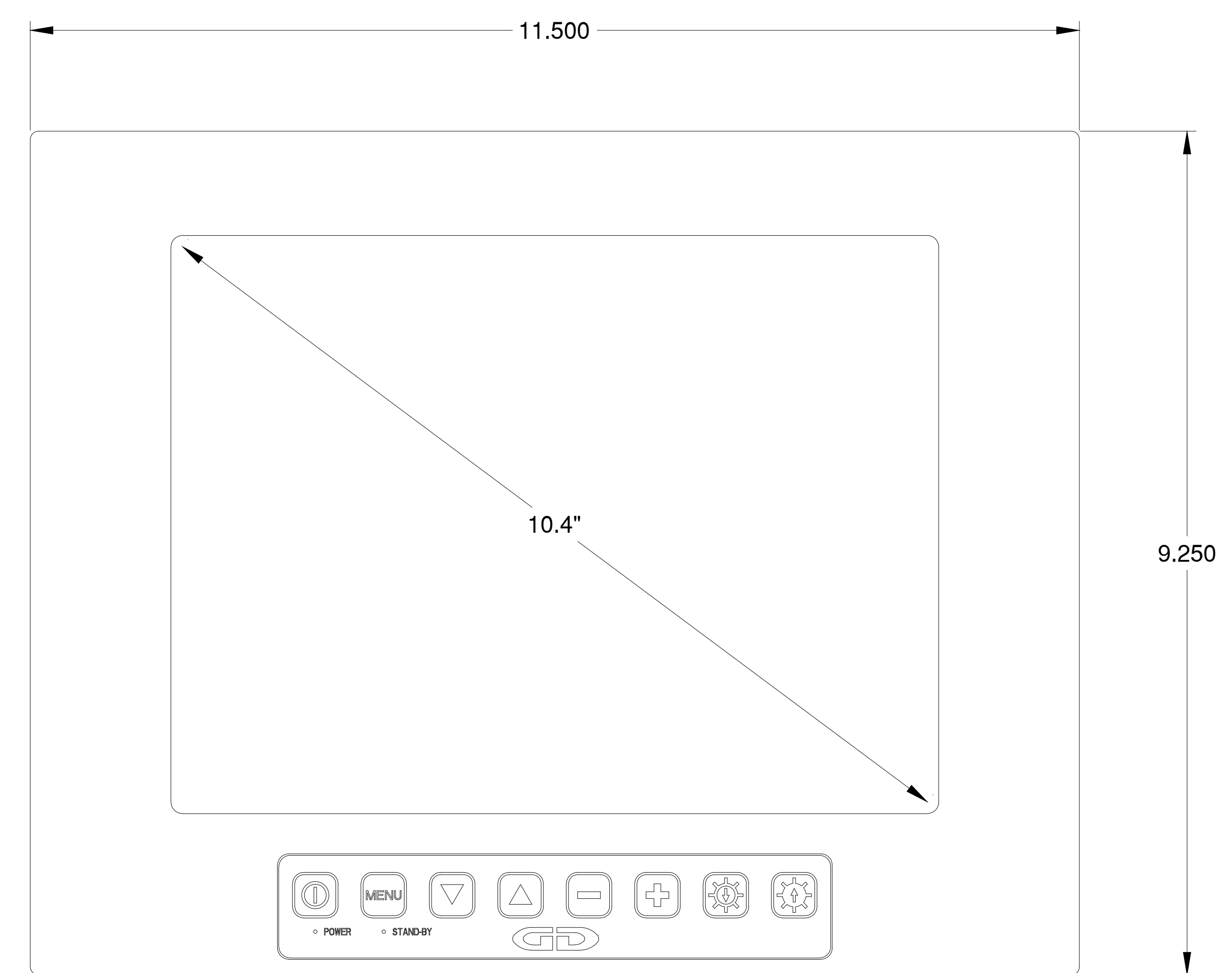
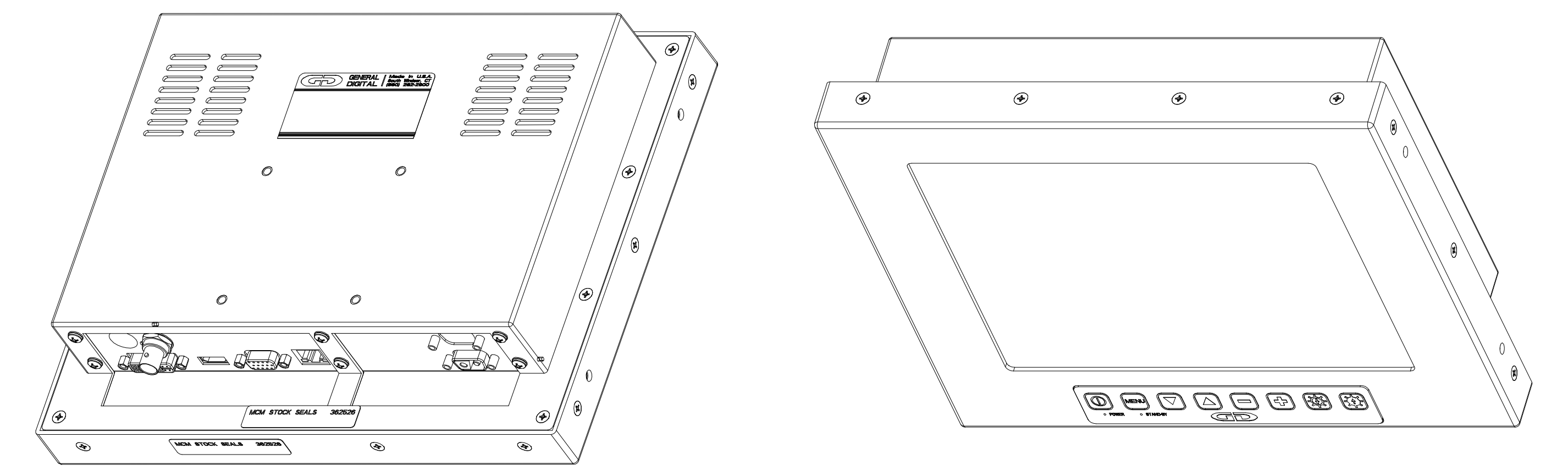
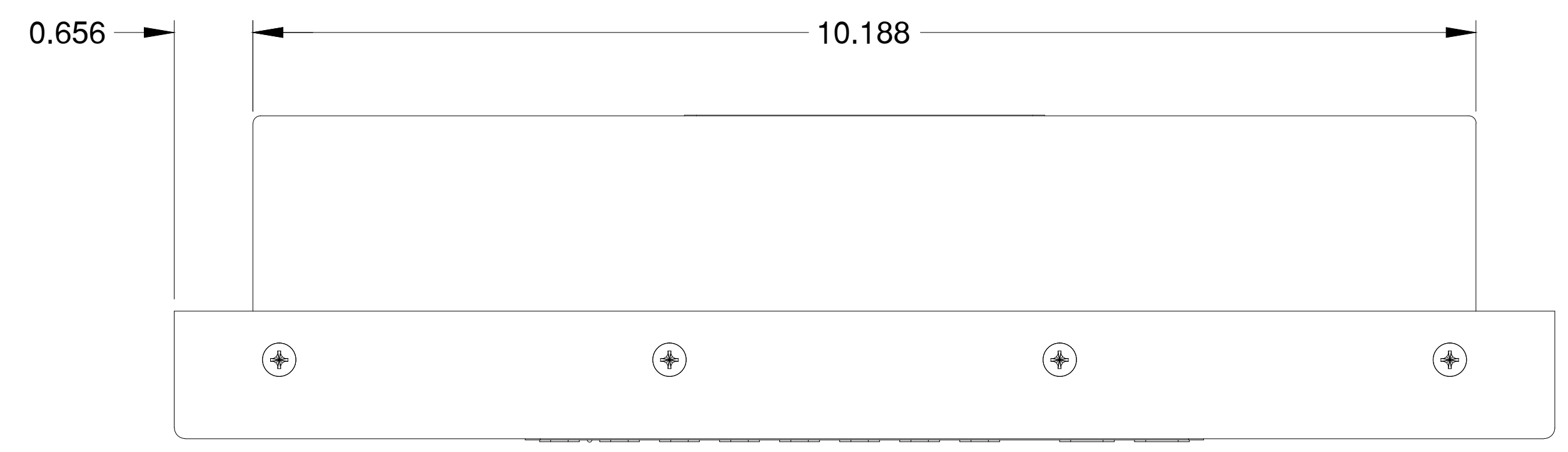
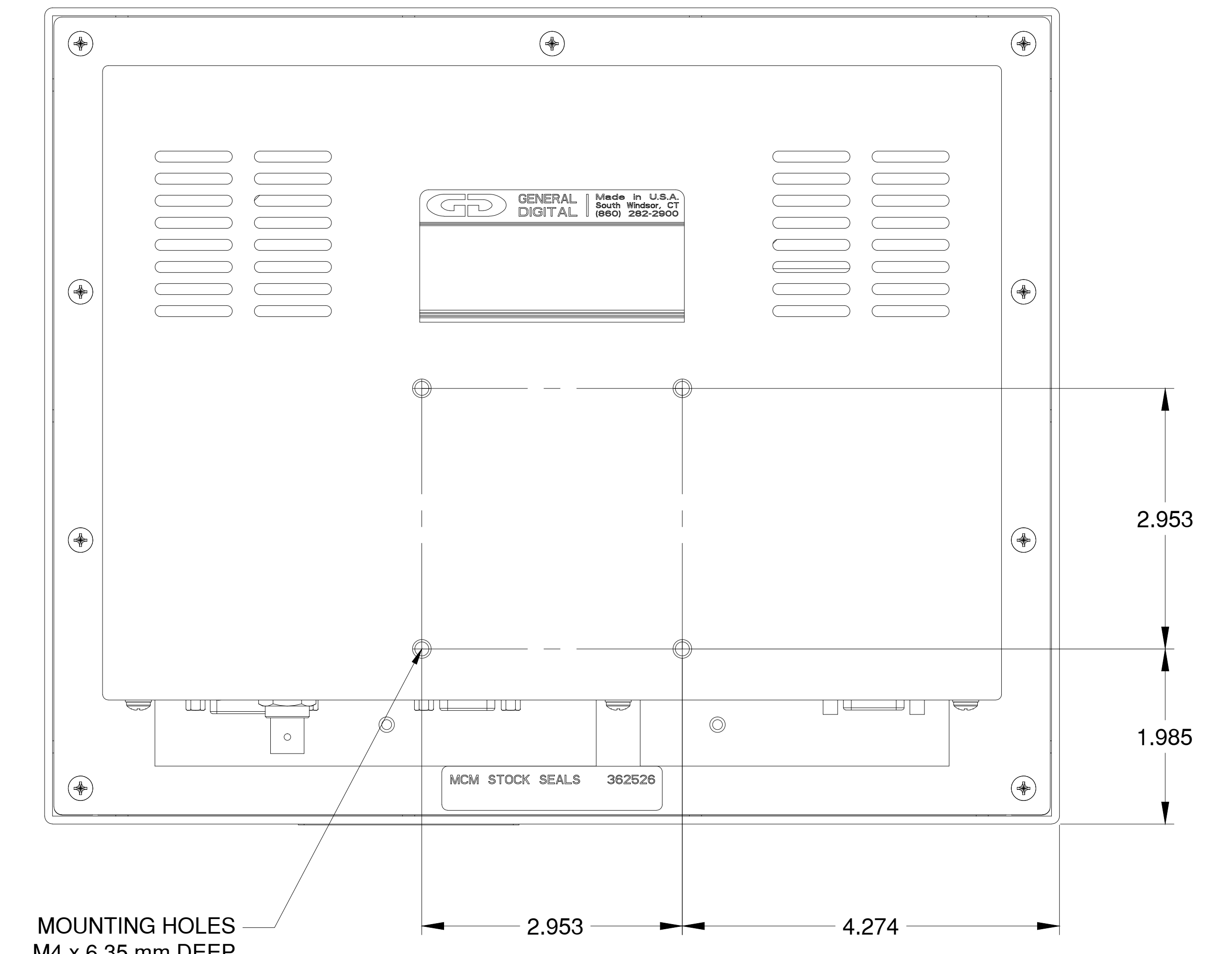

MOUNTING HOLES  
M4 x 6.35 mm DEEP  
(x8)

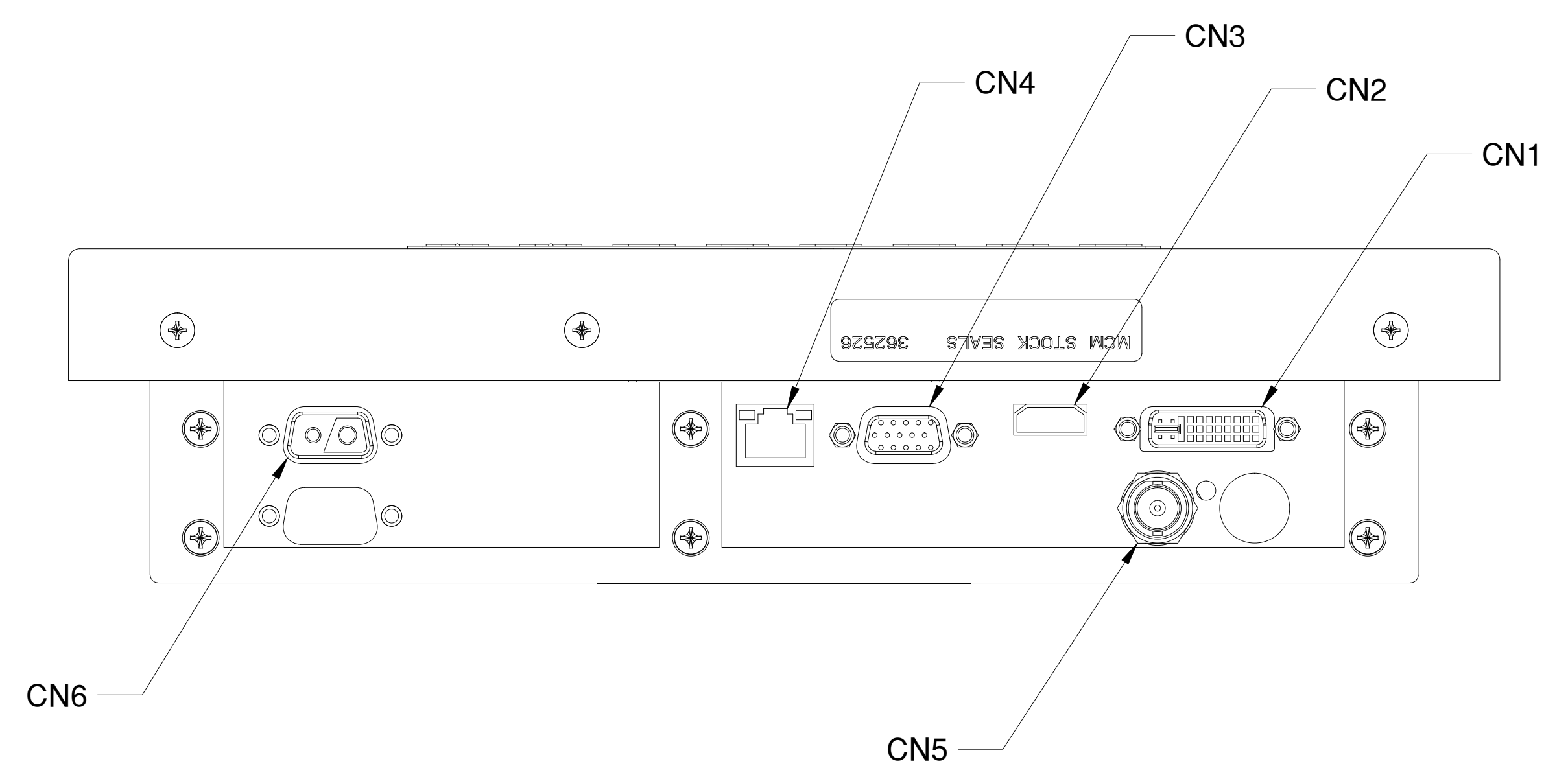

THIS DOCUMENT CONTAINS PROPRIETARY INFORMATION OF GENERAL DIGITAL AND IS NOT TO BE DISCLOSED, REPRODUCED OR PUBLISHED WITHOUT WRITTEN CONSENT FROM GENERAL DIGITAL. THIS DOCUMENT MUST BE RENDERED ILLEGIBLE WHEN BEING DISCARDED. © COPYRIGHT 2014. ALL RIGHTS RESERVED.

UNLESS OTHERWISE SPECIFIED DIMENSIONS ARE IN INCHES  
TOLERANCES ARE:  
FRACTIONS DECIMALS ANGLES  
±1/32 .X ±.050 ±0° 30'  
.XX ±.031  
.XXX±.020

CONNECTOR CHART		
DESIGNATION	FUNCTION	TYPE
CN1	DVI-D INPUT	DVI-D
CN2	HDMI INPUT	HDMI CONN
CN3	ANALOG VIDEO INPUT	DE-15-S
CN4	ETHERNET CONNECTION	RJ45 CONN
CN5	COMPOSITE VIDEO	BNC JACK
CN6	+24 VDC INPUT	DE-2W2-P

MECHANICAL OUTLINE ONLY. SPECIFICATIONS SUBJECT TO CHANGE WITHOUT NOTICE. U.O.S. ALL DIMENSIONS ARE IN INCHES.	
APPROVALS	DATE
DRAWN G.L.	07-Jul-14
CHECKED T.R.	
APPROVED B.G.	
<b>DO NOT SCALE DRAWING</b>	



**GENERAL DIGITAL**  
*The Innovators of Flat Panel Technology*  
8 Nutmeg Road South, South Windsor, CT 06074  
(860) 282-2900 www.GeneralDigital.com

**SABER STANDALONE**  
**10.4" XGA MONITOR**

<b>B</b>	CAGE CODE 1JA77	DWG. NO. 14-55	REV -
----------	--------------------	-------------------	----------

REV	DATE	ECN	DESCRIPTION	BY