

(X) OPTION	UNIT DESCRIPTION
-	SABER RACKMOUNT
S	SABER RACKMOUNT SOLAR
SN	SABER RACKMOUNT SOLAR/NVIS
D	SABER RACKMOUNT DAYLIGHT READABLE

(X)RM-20U-cccc-107-00-16-gg-SA39-000

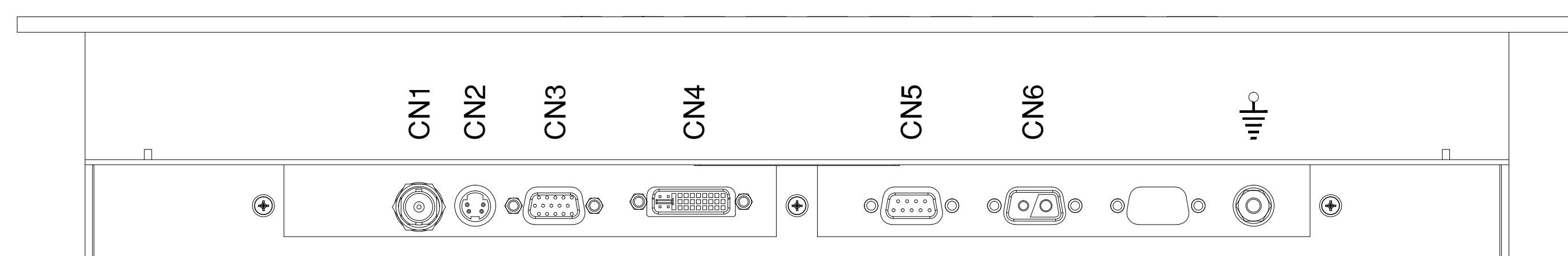
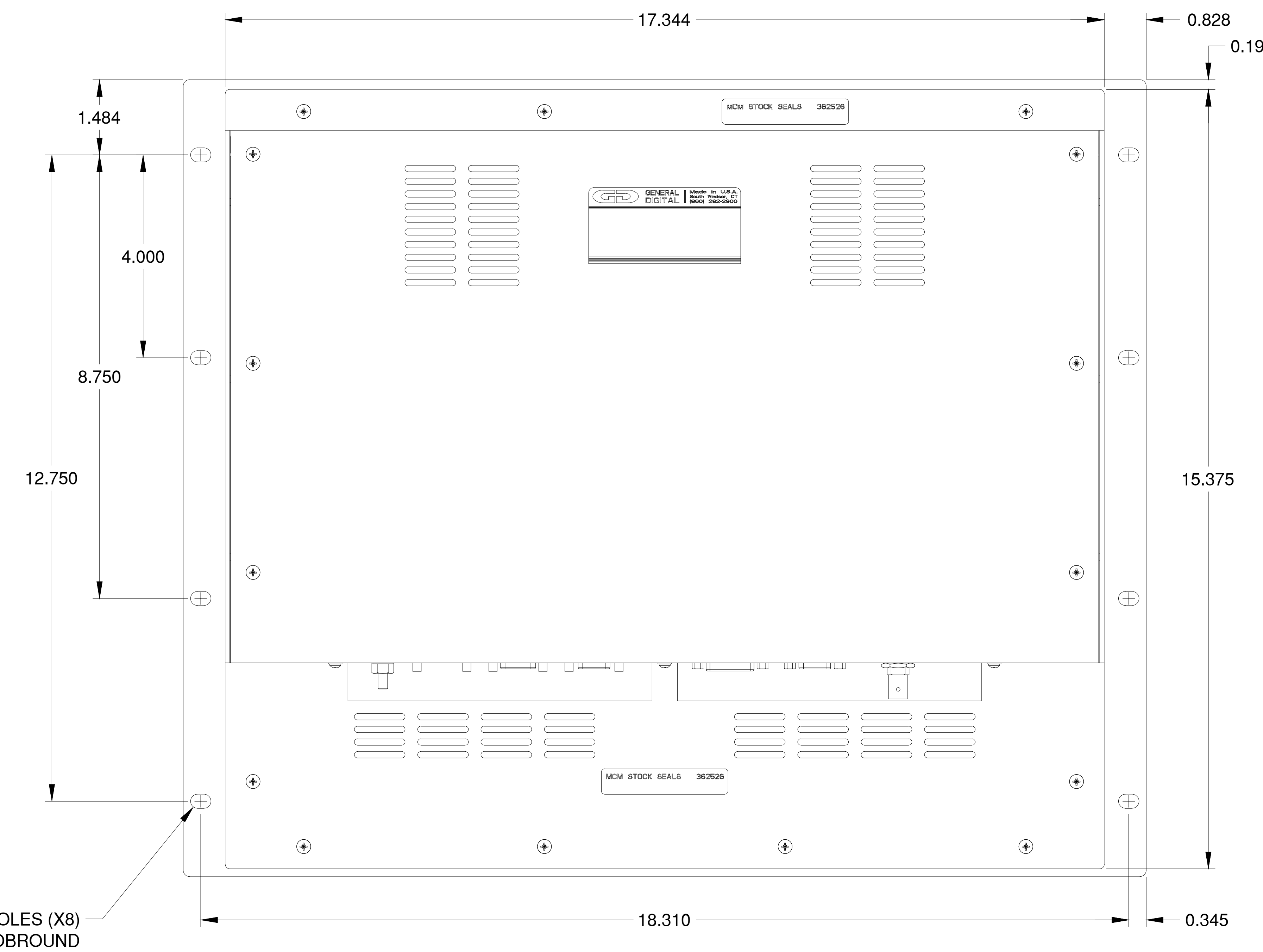
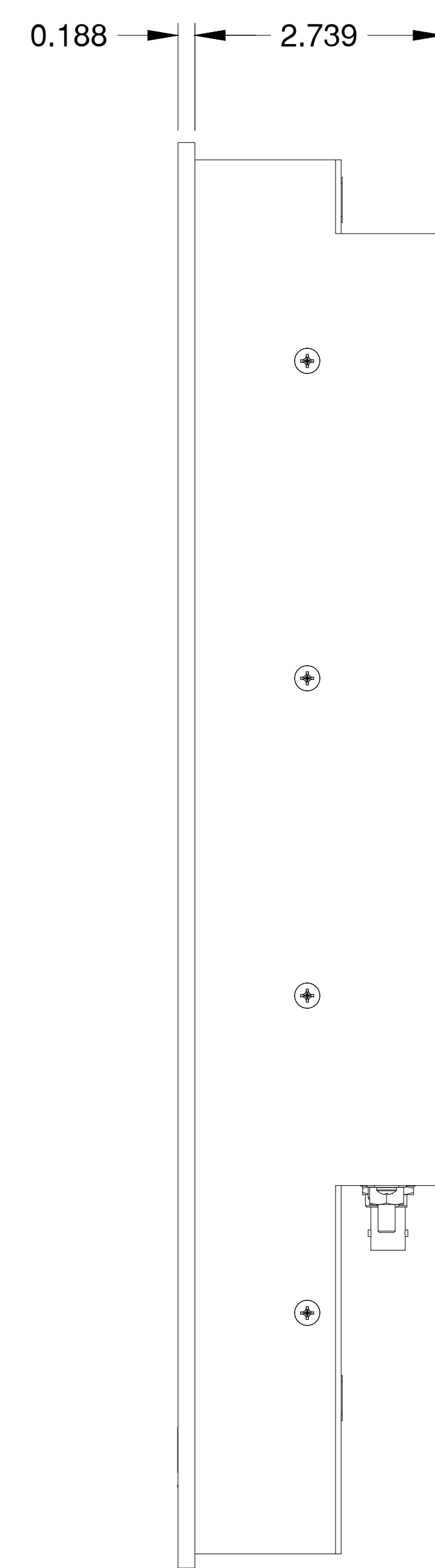
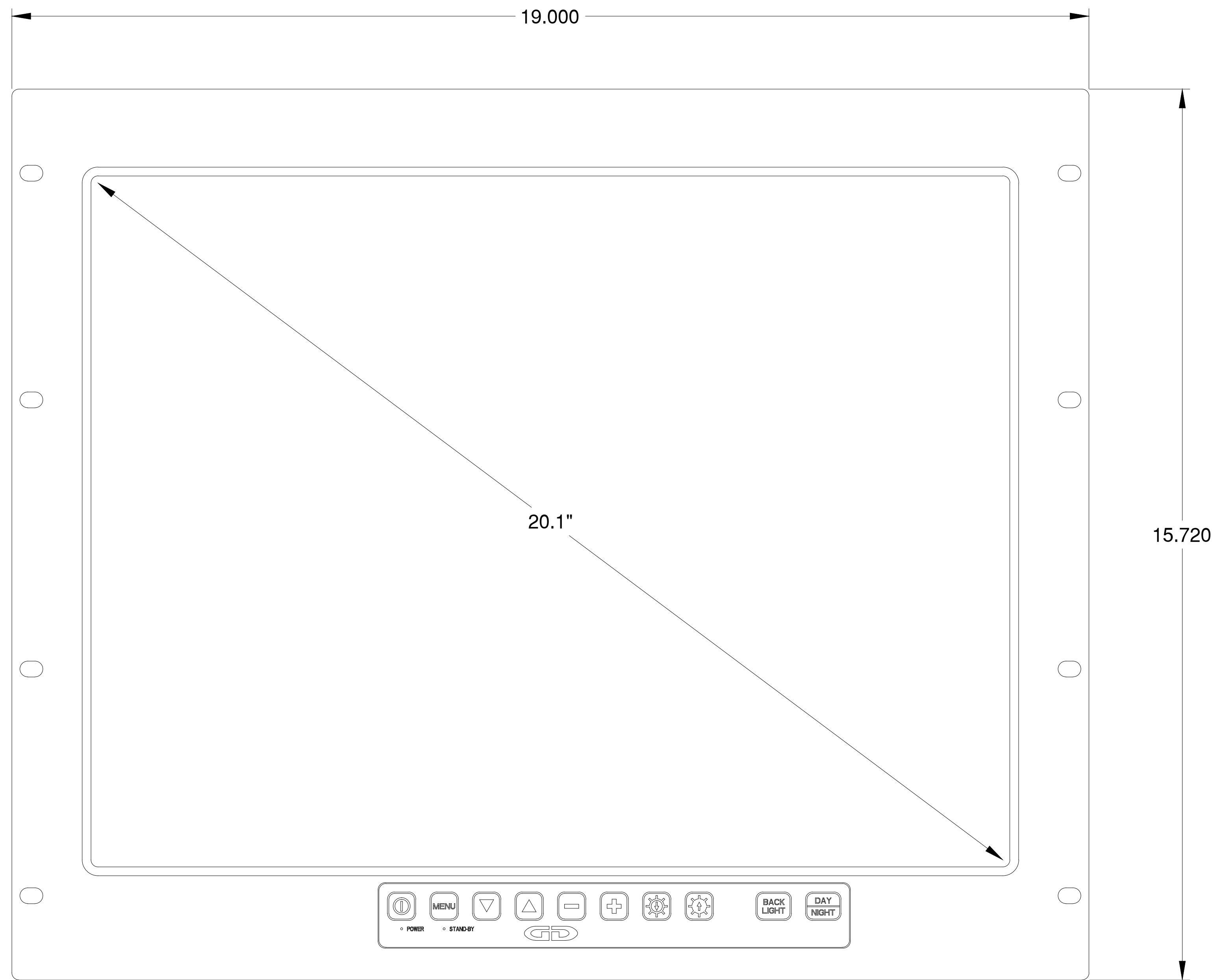
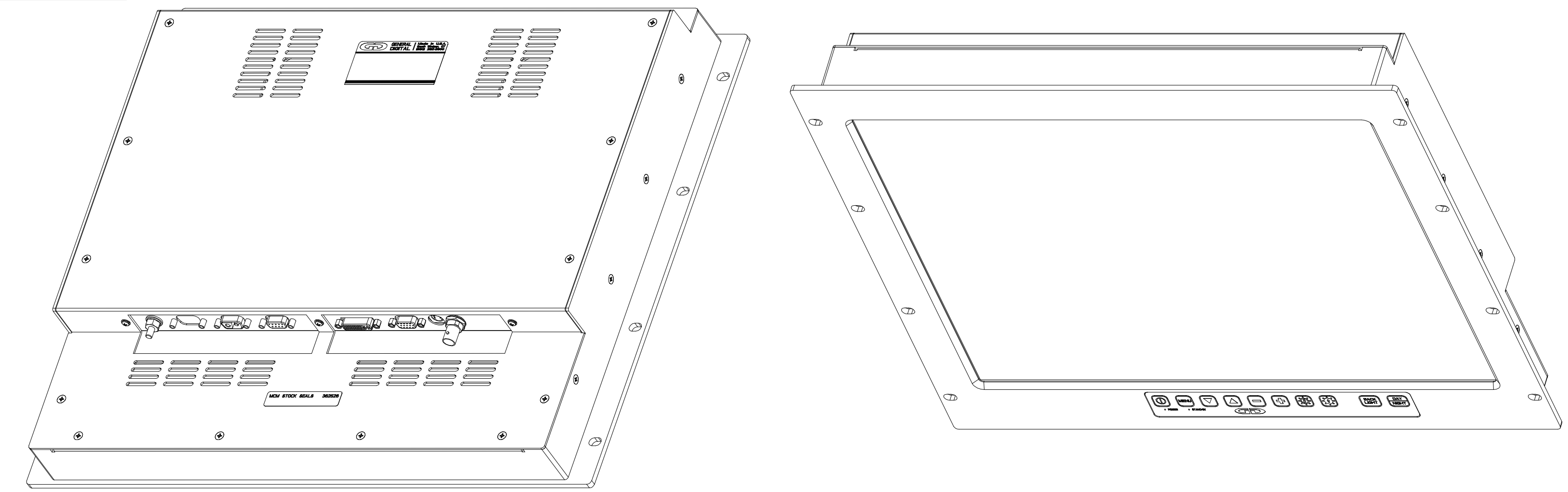
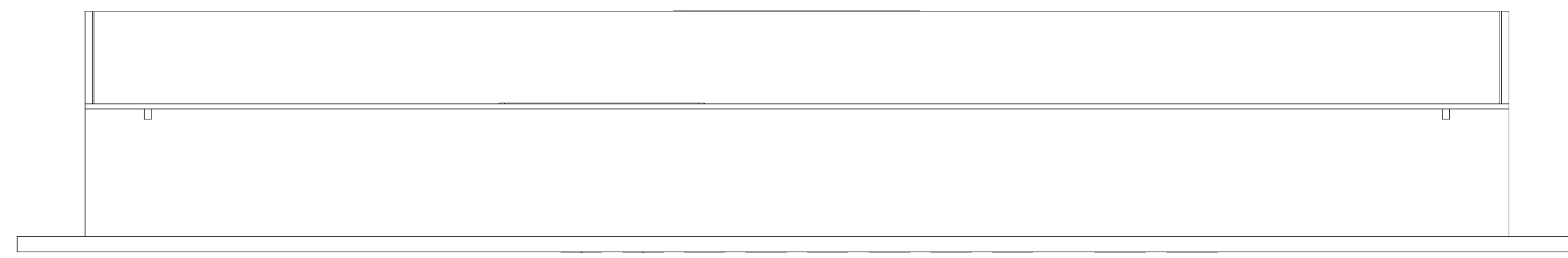

THIS DOCUMENT CONTAINS PROPRIETARY INFORMATION OF GENERAL DIGITAL AND IS NOT TO BE DISCLOSED, REPRODUCED OR PUBLISHED WITHOUT WRITTEN CONSENT FROM GENERAL DIGITAL. THIS DOCUMENT MUST BE RENDERED ILLEGIBLE WHEN BEING DISCARDED. © COPYRIGHT 2013. ALL RIGHTS RESERVED.

UNLESS OTHERWISE SPECIFIED DIMENSIONS ARE IN INCHES
 TOLERANCES ARE:
 FRACTIONS DECIMALS ANGLES
 ±1/32 .X ±.050 ±0° 30'
 .XX ±.031
 .XXX±.020

CONNECTOR CHART		
DESIGNATION	FUNCTION	TYPE
CN1	COMPOSITE VIDEO INPUT	BNC STYLE
CN2	S VIDEO INPUT	4-PIN MINI DIN
CN3	ANALOG VIDEO INPUT	DE-15-S
CN4	DVI-I INPUT	DVI-I
CN5	USB (TOUCH)	DE-9-S
CN6	+24 VDC INPUT	DE-2W2-P

MECHANICAL OUTLINE ONLY. SPECIFICATIONS SUBJECT TO CHANGE WITHOUT NOTICE. U.O.S. ALL DIMENSIONS ARE IN INCHES.	
APPROVALS	DATE
DRAWN G.L.	15-May-14
CHECKED J.H.	
APPROVED K.H.	
DO NOT SCALE DRAWING	



GENERAL DIGITAL
The Innovators of Flat Panel Technology
 8 Nutmeg Road South, South Windsor, CT 06074
 (860) 282-2900 www.GeneralDigital.com

SABER RACKMOUNT		
20.1" UXGA MONITOR		
B	CAGE CODE 1JA77	DWG. NO. 14-53
REV A		

REV	DATE	ECN	DESCRIPTION	BY
A	09-Jul-14	-	ADDED DISPLAY OPTIONS TABLE	GL