

# BP-19W-702-dd-00-15-gg-hij

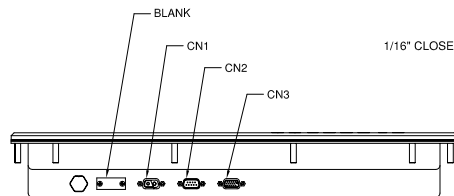
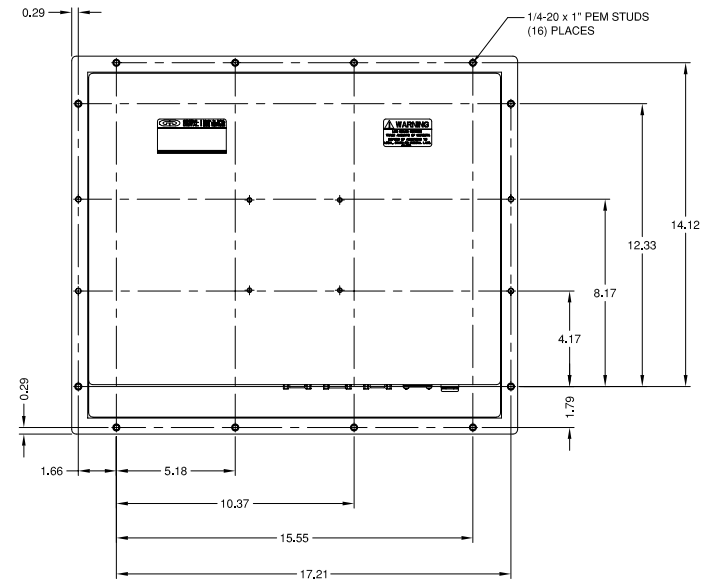
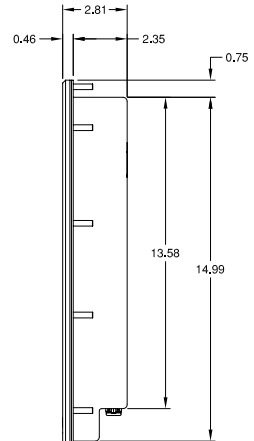
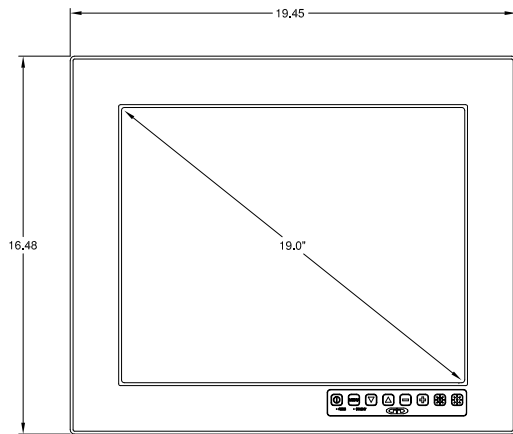
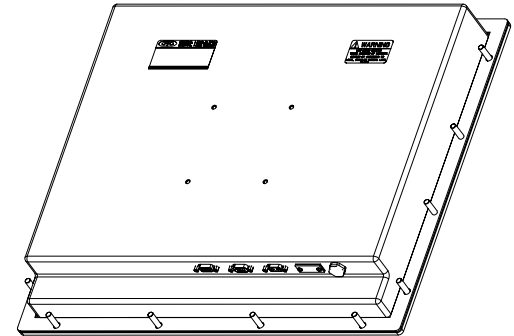
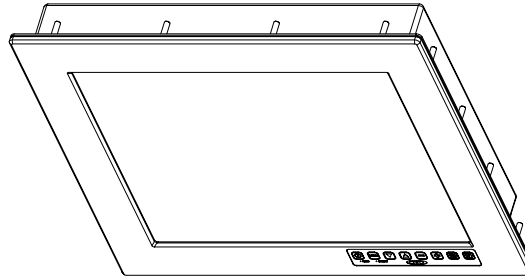
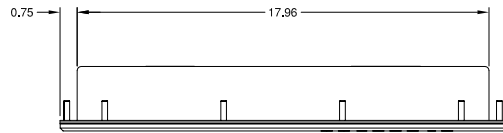

0.31 PANEL THICKNESS  
PANEL MOUNT ADAPTER PLATE

1/16" CLOSED CELL SILICONE SPONGE DIECUT GASKET

THIS DOCUMENT CONTAINS PROPRIETARY INFORMATION OF GENERAL DIGITAL AND IS NOT TO BE DISCLOSED, REPRODUCED OR PUBLISHED WITHOUT WRITTEN CONSENT FROM GENERAL DIGITAL. THIS DOCUMENT MUST BE RENDERED ILLEGIBLE WHEN BEING DISCARDED. © COPYRIGHT 2009. ALL RIGHTS RESERVED.

UNLESS OTHERWISE SPECIFIED DIMENSIONS ARE IN INCHES  
TOLERANCES ARE:  
FRACTIONS DECIMALS ANGLES  
±1/32 .X ±.050 ±0° 30'  
.XX ±.031  
.XXX±.020

### CONNECTOR CHART

DESIGNATION	FUNCTION	TYPE
CN1	+12 VDC INPUT	DE-2W2P
CN2	NTSC VIDEO INPUT	DE-9S
CN3	ANALOG VIDEO INPUT	DE-15S

MECHANICAL OUTLINE ONLY. SPECIFICATIONS SUBJECT TO CHANGE WITHOUT NOTICE. U.O.S. ALL DIMENSIONS ARE IN INCHES.

APPROVALS	DATE
DRAWN FLA	15-July-09
CHECKED T.R.	15-July-09
APPROVED B.G.	15-July-09

DO NOT SCALE DRAWING



### SEALED PANEL MOUNT MONITOR 19" VGA FLAT PANEL MONITOR

<b>B</b>	CAGE CODE 1JA77	DWG. NO. 09-41	REV -
----------	--------------------	-------------------	----------

REV	DATE	ECN	DESCRIPTION	BY